

preface

Thank you for choosing our vector general type inverter.

Vector universal frequency converter is a high-performance common frequency converter, mainly used to control and adjust the speed of a three-phase AC asynchronous motor. Adopt high-performance vector control technology, low speed and high torque output, has good dynamic characteristics, super overload capacity, increased user programmable function and background monitoring software, communication bus function, support a variety of PG cards, etc., the combination of rich and powerful functions, stable performance. Can be used in textile, paper, wire drawing, machine tool, packaging, food, fan, water pump and various automatic production equipment drive. In order to use the product well and ensure the safety of users, please read the use instruction manual in detail before you use it, and please keep it properly, for later use.

When you find any problems in your use and this manual cannot provide you with answers, please contact our company dealers everywhere, or contact the company directly, and our professional staff will actively serve you. And please continue to follow and follow the company's products.

Materials are subject to change without prior notice

catalogue

preface 1

Use need to know 3

Chapter-1 Inspections 4

 1.1 Check the items 4

 1.2 Nameplate data 4

Chapter-2 Installation 5

 2.1 Use environment 5

Chapter-3 Wring 7

 3.1 Terminal terminal 7

 3.2 Application and precautions of peripheral equipment 11

Chapter-4 Keypad operation 13

 4.1 Keyboard description 13

 4.2 Functional Parameter Table 15

Chapter-5 Troubleshooting 61

 5.1 Fault information and troubleshooting method 61

 5.2 Common faults and their handling methods 65

Chapter-6 Maintenance and Maintenance 66

 6.1 Daily maintenance 66

 6.2 Periodic maintenance 66

 6.3 Replacement of vulnerable parts of frequency converter 66

 6.4 Warranty of the frequency converter 66

Chapter-7 Communication Agreement 67

 7.1 Definition of the communication data address 67

 7.2 Modbus communication protocol 70

Appendix A for Installation and Dimensions (mm) 78

Use need to know

The safe operation of this product depends on the proper transportation, installation, operation and maintenance, and please pay attention to the safety tips before proceeding these them.



When wrong use, can cause danger, may cause personal casualties.



When wrong use, can cause danger, may cause personal injury or equipment damage.



WARNING

- Do not touch the circuit board and other components after the power is turned off and the charging indicator is off.
- No wiring during power transmission. Do not check the components and signals on the circuit board during operation.
- Do not disassemble or change the internal cables, lines and components of the inverter.
- The frequency converter grounding terminal must be grounded correctly. Grade 220V: the third grounding, Class 440V: special grounding.



CAUTION

- Do not conduct voltage resistance on components inside the inverter, which are vulnerable to high voltage damage.
- Never connect the inverter output terminals U, V, and W to the AC power supply.
- The IC of CMOS on the frequency converter circuit board is vulnerable to static influence and damage. Do not touch the main circuit board.

Chapter-1 Inspections



CAUTION

Please don't install the damaged inverter and the inverter with missing components, there is the risk of injury.

Although the products of the company have been strictly inspected before leaving the factory, please check them carefully after the purchase.

1.1 Check the items

When getting the product, please confirm the following items:

Confirm the project	Confirmation method
Order with the commodity machine type and model is consistent	Please confirm the nameplate on the side
Whether the parts are damaged or damaged in any places	Check the overall appearance and check for damage during transportation
Whether the screws and other fastening parts are loose	When necessary, check with a screwdriver
Instructions, qualification certificate and other accessories	Operating manual and corresponding accessories

For any abnormal situation, please contact the supplier or our Marketing Department directly.

1.2 Nameplate data

1.2.1 Type description of the frequency converter

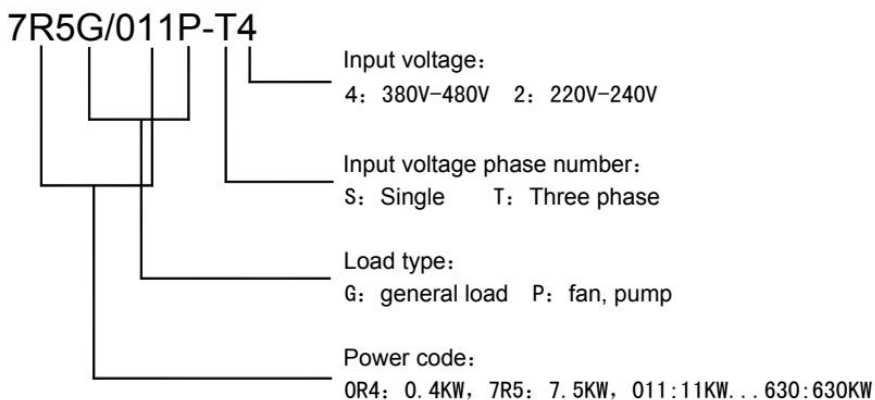

Chapter-2 Installation

2.1 Use environment

The installation environment of frequency converter has a direct impact on the normal function and its service life, so the installation environment of frequency converter must meet the following conditions.

- Surrounding temperature: open cabinet open (-10~45°C / + 14~113 °F); locked wall mounted (-10~40°C / + 14~104 °F)
- Prevent rain from getting wet or wet environment.
- Avoid direct exposure.
- Prevent oil spray, salt erosion.
- Prevent corrosive liquids, gas.
- Prevent dust, cotton wool and metal debris from entering.
- Stay away from radioactive substances and combustible materials.
- Prevent electromagnetic interference (welding machine, power machine)
- Prevent vibration (punch), and add shock-proof shims to reduce vibration.
- When several frequency converters are installed in the control cabinet, please pay attention to the position for easy heat dissipation, and please add a cooling fan to make the temperature around the frequency converter is lower than 45°C.

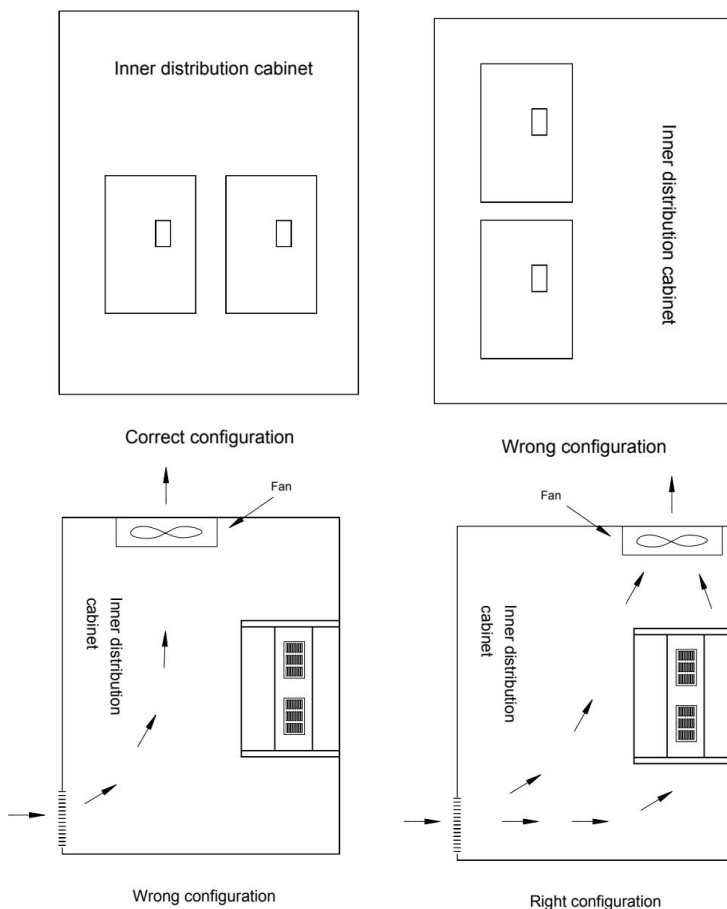

- Please position the inverter front forward and top up for heat dissipation.
- The installation space must comply with the following provisions: (if installed in the cabinet or around the ambient permit, lower the dust-proof upper cover of the converter for heat dissipation and ventilation)

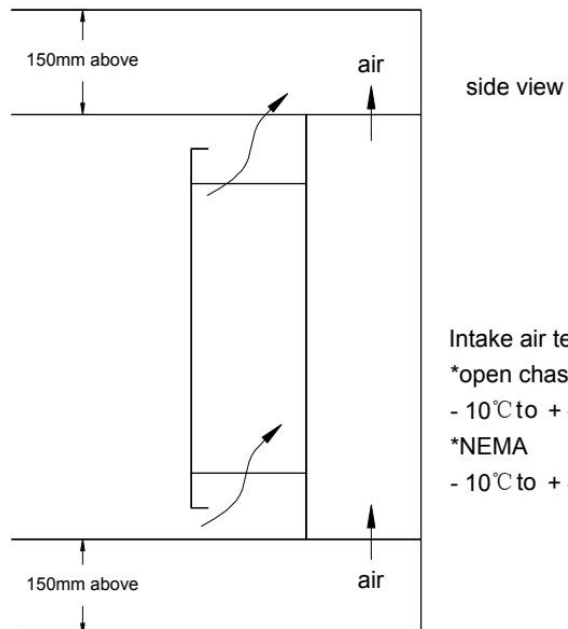
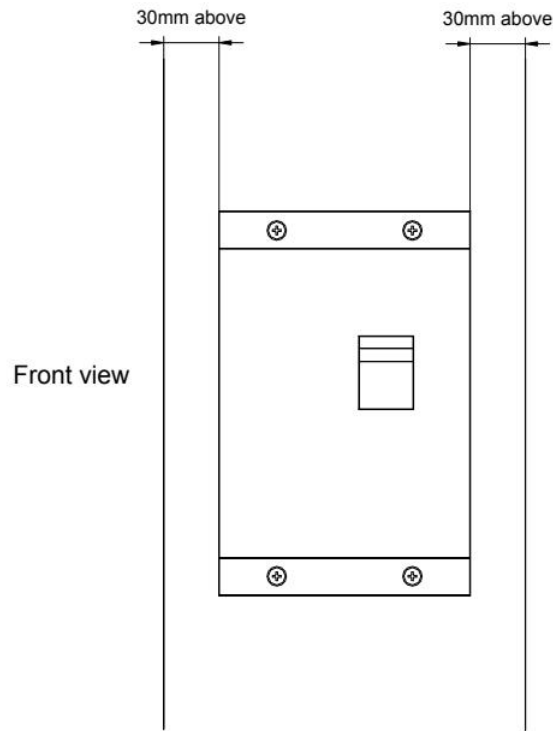

Chapter-3 Wiring

3.1 Terminal terminal

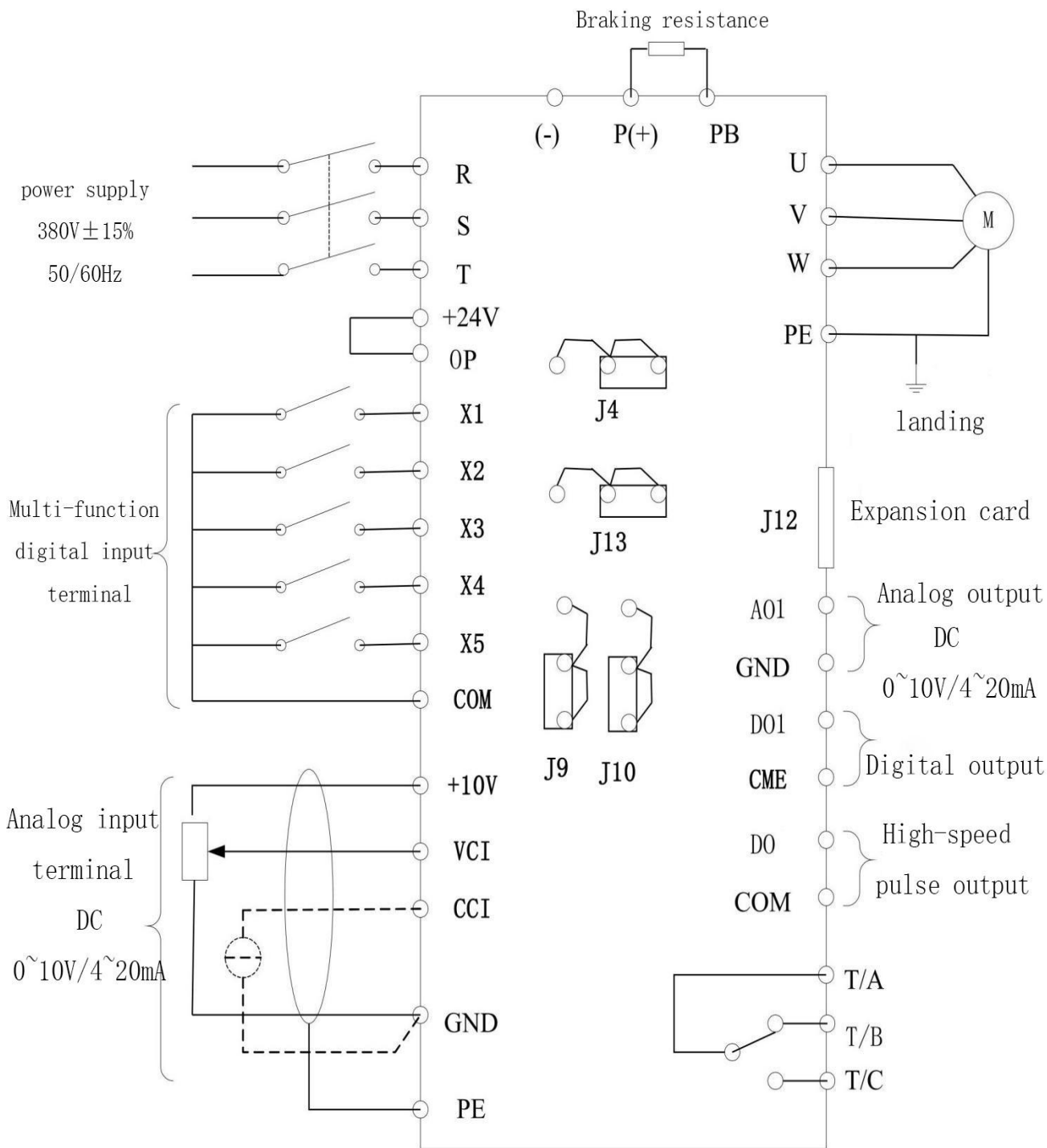
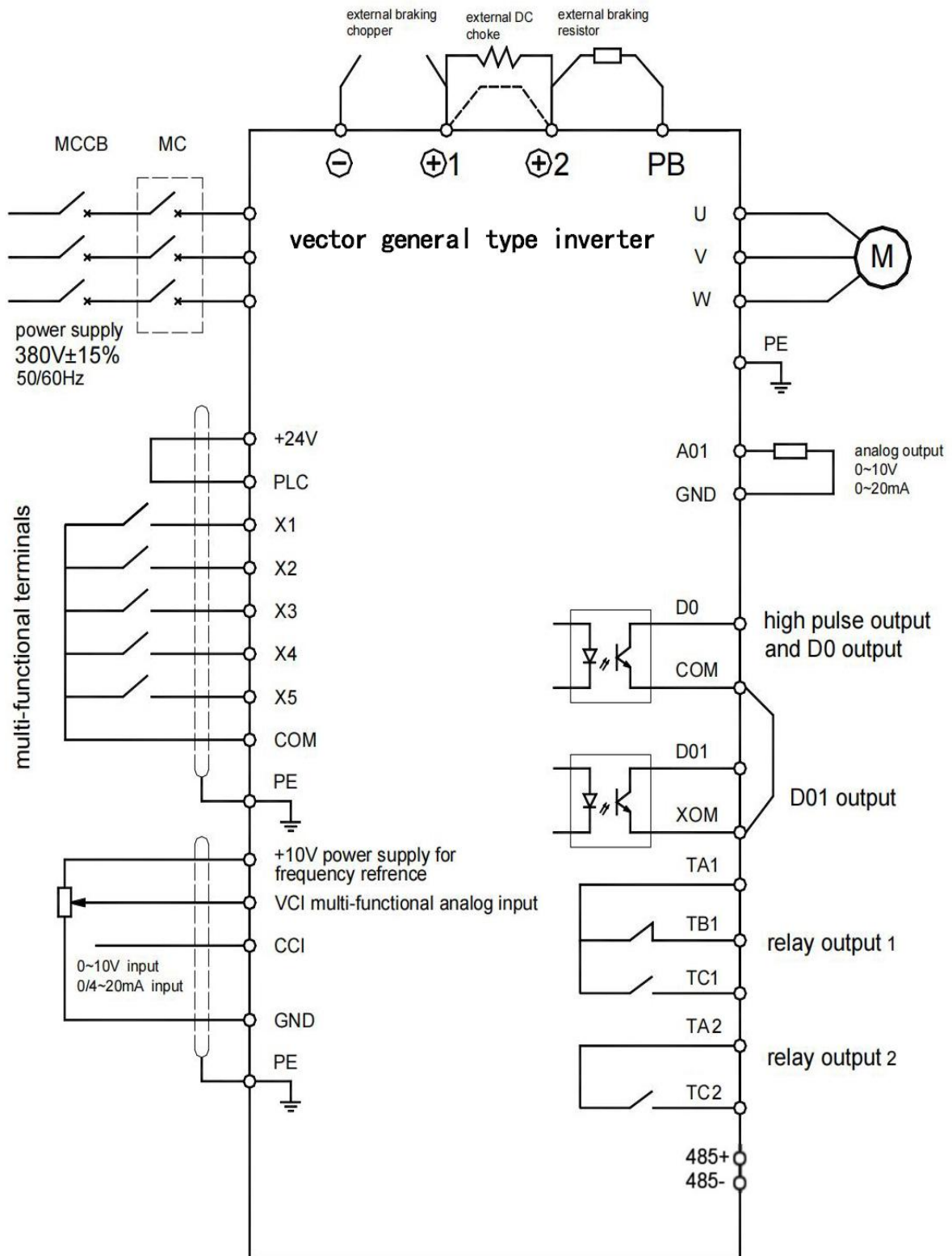



Fig3-1 Applicable to 650S



Wiring diagram

Fig3-2 Applicable to 650L

The functions of the terminals of the main loop are described as follows:

Terminal name	function declaration
R、 S、 T	Three-phase power supply input
P,(+),(+)1、 N,(-)	External brake unit reserved terminal
P, (+) 、 PB	External brake resistance reserved
(+) 1、 (+) 2	External DC reactor reserved terminal
U、 V、 W	Three-phase AC output terminal
 PE	earth terminal

Terminal diagram

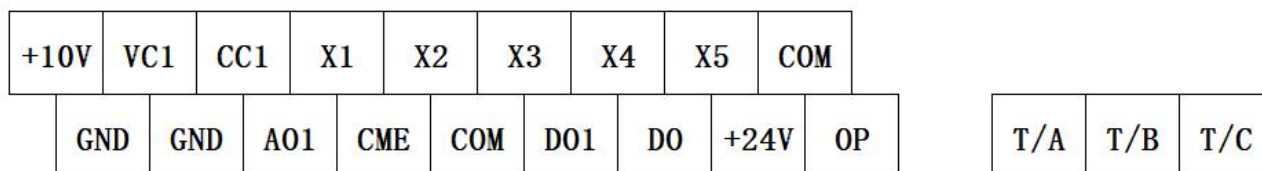

Fig3-3 Applicable to 650S

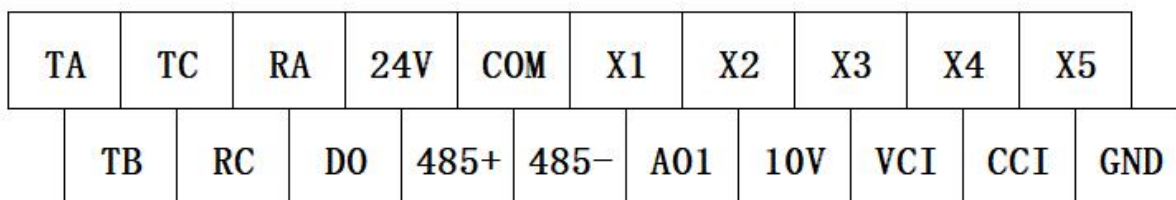

Fig3-4 Applicable to 650L

Description of the control board terminal

class	Terminal symbol	Terminal name	function declaration
source	+10V-GND	External connection with a + 10V power supply	Provide + 10V power supply, maximum output current: 10 mA Generally used as the working power supply of external potentiometer, potentiometer resistance range: 1 kΩ ~ 5 kΩ
	+24V-COM	External connection with a + 24V power supply	Provide + 24V power supply, generally used as digital input terminal working power supply and external sensor power supply, the maximum output current: 200 mA
	OP	External power supply input terminal	Factory default with the + 24V connection When driving X 1 to X 5 with external signals, the OP needs to be connected to the external power supply and disconnected from the + 24V electrical terminal
analog input	VCI-GND	Analog input terminal 1	Input voltage range: DC 0-10 V Input impedance: 100 kΩ

class	Terminal symbol	Terminal name	function declaration
	CCI-GND	Analog input terminal 2	1. Input range: DC 0~10V / 4 ~ 20 mA, as determined by the J3 jumper on the control panel 2. Input impedance: 100 k Ω at voltage input and 500 Ω at current input
Digital input terminal	X1-COM	Digital input 1	1, optical coupling and isolation, compatible with bipolar input 2. Input impedance: 3.3 k Ω 3, the level input voltage range: 9V~30V
	X2-COM	Digital input 2	
	X3-COM	Digital input 3	
	X4-COM	Digital input 4	
	X5-COM	Digital input 5 (high-speed pulse)	Not only has the characteristics of X1~X4, but also can be used as a high-speed pulse input channel
analog output	AO1-GND	Analog output 1	The voltage or current output is determined by the J4 jumper on the control board Specification of the output voltage: 0V~10V Output current specification: 0 mA ~ 2 mA
numeric output	DO1-CME	Digital output 1	Optical coupling isolation, bipolar open circuit collector type output Output voltage specification: 0V~24V Output current specification: 0 mA ~ 50 mA Note: the digital output CME and the digital input COM are internally isolated, but the CME and the COM have external short contact at the factory (DO 1 defaults to + 24V driver); when DO 1 wants to use the external power supply, it must break the external CME from the COM.
	DO-COM	High speed pulse output	
relay output	TA-TB	Often closed terminal	Contact point drive capability: AC: 250V、3A、cos Φ =0.4 DC: 30V、1A
	TA-TC	Often start	
Auxiliary interface	J3	PG card interface	Optional: OC, difference, UVW, rotation and other interfaces
	J12	Function extension card interface	28-core terminal, interface with optional card (I / O extension card, PLC card, various bus cards and other optional cards)
	J9	The NPN and PNP connection are selected as a jumper	Facing the control board, from top to bottom are: 24V, OP, COM
	J10		Facing the control board, from top to bottom are: empty, CME, COM
other	J4	The PE and GND connection are selected as a jumper	Choose whether PE is connected to GND, and in cases of interference, connecting PE to GND can improve the anti-interference. Factory default is not connected (facing the dashboard, jump on the left)
	J13	PE and COM connection select the jumper	Select whether PE is connected to COM. In situations with interference, connecting PE to COM can improve the anti-interference. Factory default is not connected (facing the dashboard, jump on the left)

3.2 Application and precautions of peripheral equipment

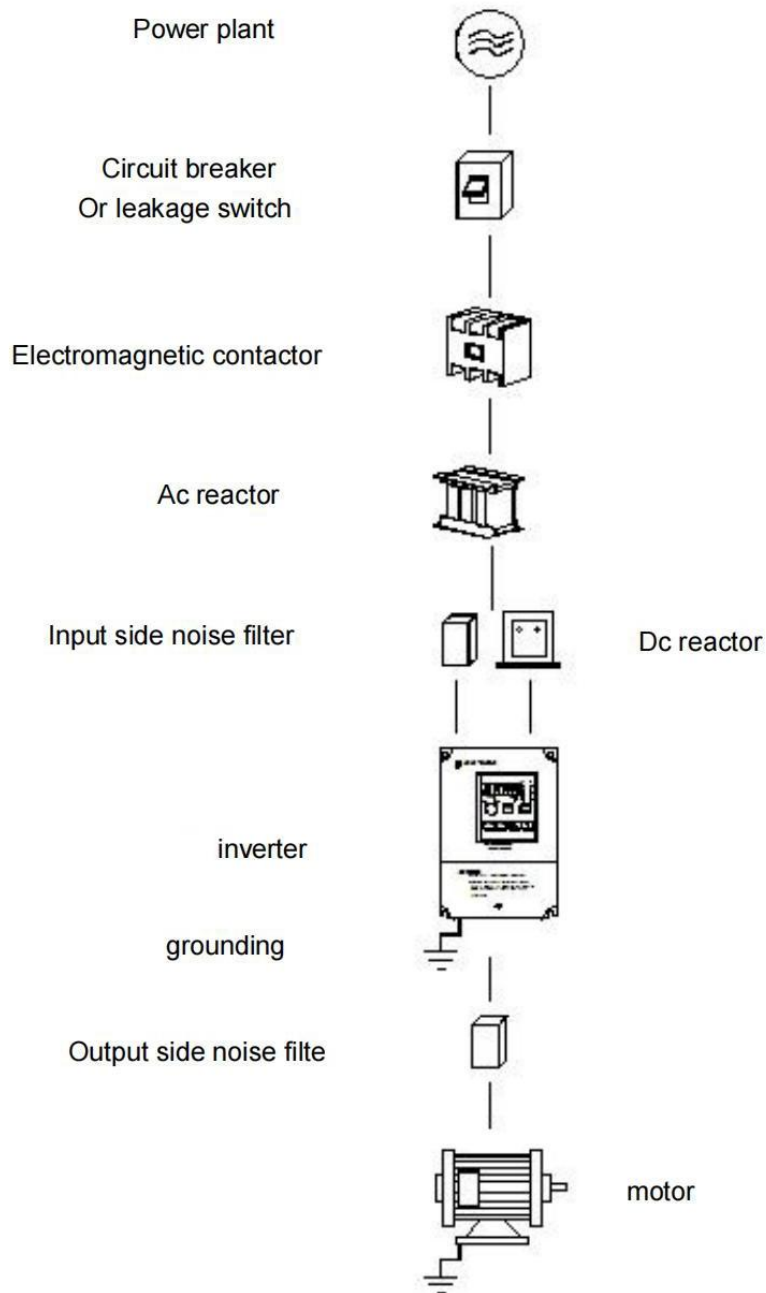

source:

- Please note that the voltage level is correct to avoid damage to the frequency converter.
- A circuit breaker or a leakage switch must be installed between the AC power supply and the frequency converter.

Circuit breaker or electric leakage switch:

- Use the circuit breaker or leakage switch conforming to the inverter rated voltage and current level as the frequency converter

power switch control, and as the protection of the frequency converter.

- Circuit breaker and leakage switch are not used as operation / stop switching function of frequency converter.
- Please install leakage circuit breaker to prevent misoperation caused by leakage and protect the safety of users.

electromagnetic contactor:

- In use, electromagnetic contactor can not be added, but used as external control, or automatic start after power failure, or in the use of brake controller, the addition of electromagnetic contactor on the side of the installation.
- Electromagnetic contactors do not use as the operation / stop switching function of the frequency converter.

AC reactor:

- For a frequency converter below 220V / 380V 15KW, a large power capacity (above 600KVA) is used to improve the power supply with A c reactor.

Input-side noise filter:

- When there is inductive load around the converter, please install the converter.

Output-side noise filter:

- Reduce the high harmonics generated by the frequency converter to avoid affecting the nearby communication devices.

any power-generating or power-driven machine:

- Please use a three-phase induction motor with a suitable inverter capacity.
- If one converter drives multiple motors, consider that the current of the motor should be less than the capacity of the converter.
- Do not add a phase capacitor between the frequency converter and the motor.
- The frequency converter and the motor must be grounded separately.

Vector universal type frequency converter:

- The input power terminals R, S, and T can be connected without phase order.
- The output terminals U, V and W are connected to the U, V and W terminals of the motor. If the frequency converter performs the positive rotation, the motor is reversed, and any two of the terminals U, V and W can be adjusted.
- Output terminals U, V, W, do not connect AC power to avoid inverter damage.
- Ground terminal, please correct grounding, 220V: third grounding, 400V: special grounding.

Chapter-4 Keypad operation

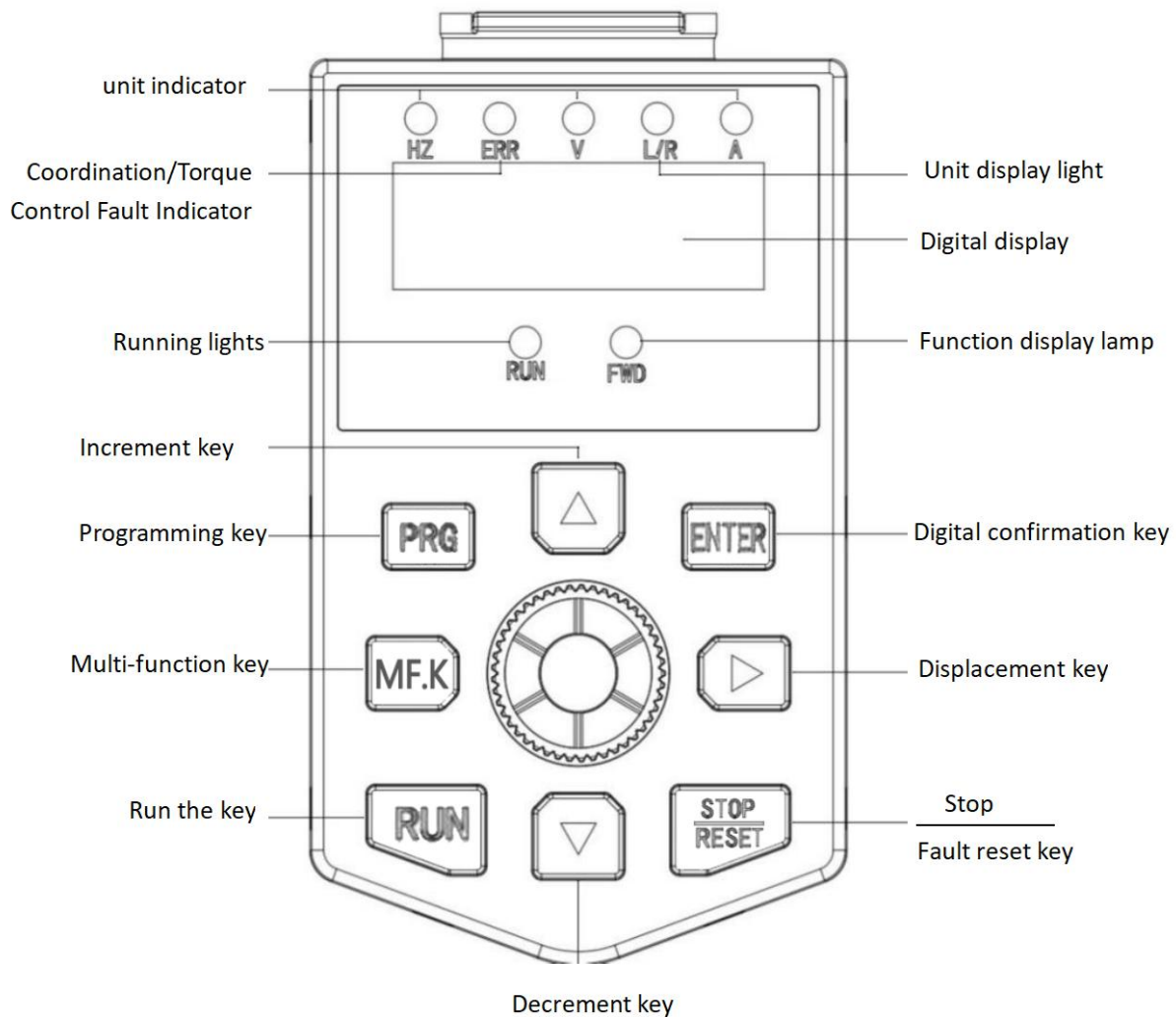

4.1 Keyboard description

4.1.1. Keyboard schematic diagram



4.1.2 Key function description

Keystone symbol	name	function declaration
	Programming key	The Level 1 menu enters or exits
	Determine the key	Enter the menu screen step by step and confirm the setting parameters
	UP increasing key	Increment of the data or function code
	The DOWN diminishing key	Declining number of the data or function codes

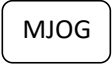
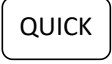
Keystone symbol	name	function declaration
	Right displacement key	Under the shutdown display interface and the running display interface, the display parameter can be selected by the right shift cycle; when modifying the parameter, the modification bit of the parameter can be selected
	Run the key	In keyboard operation mode, used for running operations
	Stop / reset key	When running state, press this key to stop operation; this function code F7.02 restriction. In the fault alarm state, all control modes can be reset with the key
	Multi-function key	According to F7.01, it can be defined as the command source, or direction rapid switch
	Menu mode selection key	on the basis of FP.03 Median switch to different menu modes (the default is one menu selection mode)

4.1.3. Description of the indicator light

1) Description of the function indicator lamp

Indicator lamp name	Indicator light description
RUN	Running state indicator: when the light is out, the inverter is in shutdown state; when the light is on, the frequency converter is in running state;
FWD/REV	Positive verse indicator: the light out indicates the positive state; the light indicates the reverse state.
LOCAL/REMOT	Control mode indicator: the light out indicates the keyboard control status; the light flashing indicates the communication control status; the light on indicates the terminal control status.
QUICK	Tuning / torque control / fault indicator lamp with light light indicating torque control mode, light slow flash indicating tuning state and light flash indicating fault state.

2) Unit indicator light instructions

Indicator lamp name	Indicator light description
Hz	Frequency unit
A	unit of current
V	voltage unit

4.2 Functional Parameter Table

FC	name	Parameters are detailed	Set the scope	default value	change	target
F0 group Basic functional group						
F0.00	Frequency converter type	1: G; 2: P	1~2	Model setting	●	0
F0.01	1.Motor control mode	0: No speed sensor and no vector control 1: Speed sensor vector control 2: V / F control	0~2	2	◎	0
F0.02	Run the instruction channel	0: Keyboard command channel (LED is off) 1: Terminal command channel (LED lit) 2: Communication instruction channel (LED flashing)	0~2	0	○	0
F0.03	Primary Frequency Source X Selection	0: Keyboard setting (power loss memory) 1: Keyboard setting (power memory) 2: Simulation quantity VCI setting 3: Simulation quantity and CCI setting 4: Panel potentiometer setting 5: High-speed pulse setting (X5) 6: Multi-segment speed running setting 7: Simple PLC program setting 8: PID control settings 9: Remote communication settings	0~9	0	◎	0
F0.04	Secondary frequency source Y selection	As with F0.03 (primary frequency source X selection)	0~9	0	◎	0
F0.05	The Y frequency instruction is the reference object selection	0: Relative maximum output frequency 1: Relative main frequency instruction	0~1	0	○	0
F0.06	The Y frequency instruction is the reference object selection range	Determine the regulatory range of the auxiliary frequency sources	0% ~ 150%	100%	○	0
F0.07	Frequency source superposition selection	Individual bit: frequency source selection 0: Main frequency instruction 1: Main and auxiliary operations result (operation relationship is determined by ten digits) 2: Switch between main frequency command and auxiliary frequency command 3: Switch between main	Each position 0~4 Ten 0~3	00	○	0

FC	name	Parameters are detailed	Set the scope	default value	change	target
		frequency command and main and auxiliary operation results 4: Switch between auxiliary frequency instruction and main and auxiliary operation results Ten digits: the frequency source main and auxiliary operation relationship 0: Main + auxiliary; 1: Main-auxiliary 2: Maximum value of both cases 3: Minimum value of both cases				
F0.08	Preset frequency	0.00 Hz~F0.10 (Maximum frequency)	0.00~F0.10	50.00Hz	○	0
F0.09	Run direction selection	0: Run in the default direction; The FWD / REV indicator light goes off; 1: Run in the opposite direction to the default direction; The FWD / REV indicator light is always on;	0~1	0	○	0
F0.10	maximun-frequency	Maximum set frequency	50.00~500.00Hz	50.00Hz	◎	0
F0.11	Upper limit frequency instruction	0: F0.12 Setting 1: VCI 2: CCI 3: Panel potentiometer 4: X5 terminal pulse setting 5: Communication given	0~5	0	◎	0
F0.12	upper limiting frequency	Lower limit frequency F 0.14 to maximum frequency F0.10	F0.14~ F0.10	50.00Hz	○	0
F0.13	Upper limit frequency bias	0.00Hz~ Maximum frequency F0.10	0.00Hz~F0.10	0.00Hz	○	0
F0.14	Lower limit frequency	0.00Hz~ upper limit frequency F0.12	0.00Hz~F0.12	0.00Hz	○	0
F0.15	carrier frequency	0.5~ 16.0kHz	0.5~16.0kHz	Model determination	○	0
F0.16	Carrier frequency is adjusted with the load size	0: No 1: Is	0~1	1	○	0
F0.17	Acceleration time 1	0.00~650.00s(F0.19=2) 0.0~6500.0s(F0.19=1) 0~65000s(F0.19=0)	0.00~65000	Model determination	○	0
F0.18	Slow down time 1	0.00~650.00s(F0.19=2); 0.0~6500.0s(F0.19=1); 0~65000s(F0.19=0)	0.00~65000	Model determination	○	0
F0.19	Increase and deceleration time unit	0: 1s 1: 0.1s 2: 0.01s	0~2	1	◎	0

FC	name	Parameters are detailed	Set the scope	default value	change	target
F0.21	Auxiliary frequency source bias frequency on stacking	0.00Hz ~ Maximum frequency F0.10	0.00Hz~F0.10	0.00Hz	○	0
F0.22	Frequency command resolution	2:0.01Hz	0.00Hz~F0.10	2	○	0
F0.23	Digital setting frequency shutdown memory selection	0: Don't remember 1: memory	0~1	0	○	0
F0.24	Motor parameter group selection	0: Motor parameter group 1; 1: Motor parameter group 2	0~1	0	◎	0
F0.25	Increase and deceleration time reference frequency	0: Maximum frequency (F0-10) 1: Set the frequency; 2: 100Hz	0~1	0	◎	0
F0.26	Runtime frequency instruction UP / DOWN baseline	0: Run frequency 1: Set the frequency	0~1	0	◎	0
F0.27	Run instruction bundle main frequency instruction selection	Individual bit: Operation panel command binding frequency source selection 0: No binding 1: Digital set frequency 2: VCI 3: CCI 4: Panel potentiometer 5: Pulse setting (X5) 6: Multi-section speed 7: Simple PLC 8: PID 9: Communication given Ten digit: Terminal command binding frequency source selection 100 bits: communication command binding frequency source selection	0~1	0000	○	0
F0.28	Communication protocol selection	0: The MODBUS-RTU protocol 1: The Profibus-DP protocol or the CANopen protocol	0~1	0	◎	0
F1 Group Motor Parameters						
F1.00	Motor type selection	0: Ordinary Asynchronous motor 1: Inverency Asynchronous motor	0~1	Model determination	◎	0
F1.01	The motor is rated power	0.1~1000.0kW	0.1~1000.0	Model determination	◎	0
F1.02	The motor is rated voltage	1~2000V	1~2000	Model determination	◎	0
F1.03	Rated current of motor	0.01~655.35A (frequency converter power: 55kW)0.1~6553.5A (frequency converter power:> 55kW)	0.01~6553.5	Model determination	◎	0

FC	name	Parameters are detailed	Set the scope	default value	change	target
F1.04	Rated frequency of motor	0.01Hz ~ Maximum frequency	0.00~F0.10	Model determination	⊙	0
F1.05	Motor rated speed	1~65535rpm	1~65535	Model determination	⊙	0
F1.06	Aynchronous motor stator resistance	0.001~ 65.535 Ω (frequency converter power 55kW) 0.0001~6.5535Ω(frequency converter power> 55kW)	0.0001~65.535	Tuning parameters	⊙	0
F1.07	Asochronous motor rotor resistance	0.001~ 65.535 Ω (frequency converter power 55kW) 0.0001~ 6.5535 Ω (frequency converter power> 55kW)	0.0001~65.535	Tuning parameters	⊙	0
F1.08	Leakresistance of asynchronous motor	0.01~ 655.35mH (frequency converter power: 55kW) 0.001~65.535mH (frequency converter power> 55kW)	0.001~655.35	Tuning parameters	⊙	0
F1.09	Aynchronous motor mutual resistance	0.1~6553.5mH (frequency converter power: 55kW) 0.01 ~ 655.35mH (frequency converter power> 55kW)	0.01~6553.5	Tuning parameters	⊙	0
F1.10	No load current of asynchronous motor	0.01A~F1.03 (frequency converter power: 55kW) 0.01~ F1.03 (frequency converter power> 55kW)	0.01~F1.03	Tuning parameters	⊙	0
F1.27	Number of encoder lines	1~65535	1~65535	1024	⊙	0
F1.28	Encoder type	0: ABZ incremental encoder 2: Rotary transformer	0, 2	0	⊙	0
F1.30	ABZ Incremental encoder AB phase sequence	0: Forward; 1: reverse	0~1	0	⊙	0
F1.31	Encoder installation angle	0.0° ~359.9°	0.0~359.9	0.0°	⊙	0
F1.32	The UVW encoder UVW phase order	0: Forward; 1: reverse	0~1	0	⊙	0
F1.33	The UVW encoder bias angle	0.0 ~359.9°	0.0~359.9	0.0°	⊙	0
F1.34	Rotary transformer pole-logarithm	1~65535	1~65535	1	⊙	0
F1.36	Speed feedback PG disconnection detection time	0.0s: Non-action of 0.1~10.0s	0.0~10.0	0.0s	⊙	0
F1.37	Tune selection	0: No operation 1: parameter tuning of asynchronous machine 2: Dynamic and complete tuning of the asynchronous machine 3: Aynchronous static and complete tuning	0~3	0	⊙	0
F2 Group Vector Control Parameters						

FC	name	Parameters are detailed	Set the scope	default value	change	target
F2.00	Speed-loop proportional gain of 1	1~100	1~100	30	○	0
F2.01	The velocity loop integral time 1	0.01~10.00s	0.01~10.00	0.50s	○	0
F2.02	Speed loop proportional gain 2	0.00Hz~F2.05	0.00~F2.05	5.00Hz	○	0
F2.03	The velocity loop integral time 2	1~100	1~100	20	○	0
F2.04	Switch frequency 2	0.01~10.00s	0.01~10.00	1.00s	○	0
F2.05	Vector-controlled transfer gain	F2.02 ~ Maximum output frequency	F2.02~F0.10	1 0.00Hz	○	0
F2.06	The SVC speed feedback filtering time	50~200%	50~200	100%	○	0
F2.07	Speed-loop proportional gain of 1	0.000~1.000s	0.000~1.000	0.015s	○	0
F2.09	Torque upper limit instruction selection under speed control mode	0: Function code F2.10 is set 1: VCI; 2: CCI 3: Panel potentiometer 4: Pulse setting (X5) 5: Remote communication settings 6: MIN(VCI,CCI) 7: The full range of the MAX (VCI, CCI) 1-7 option corresponds to F2.10	0~7	0	○	0
F2.10	Set the torque upper limit number under the speed control mode	The upper limit of the torque in the electric state is based on the rated current of the frequency converter	0.0%~ 200.0%	150%	○	0
F2.11	Torque upper limit instruction selection under speed control mode (power generation)	0: Parameter F2-10 setting (no zone) Electric power distribution and power generation) 1: VCI 2: CCI 3: Panel potentiometer 4: Pulse setting (X5) 5: Remote communication settings 6: MIN(VCI,CCI) 7: MAX(VCI,CCI) 8: Function code F2.12 sets the full range of F 1-7 corresponding to F2.10	0~8	0	○	0
F2.12	Number limit limit setting under speed control mode (power generation)	The upper limit of the torque in the generating state is based on the rated current of the frequency converter	0.0%~ 200.0%	150%	○	0
F2.13	Excitation regulation proportional gain	0~ 60000	0~ 60000	2000	○	0

FC	name	Parameters are detailed	Set the scope	default value	change	target
F2.14	Excitation adjustment integral gain	0~ 60000	0~ 60000	1300	○	0
F2.15	Torque adjustment proportional gain	0~ 60000	0~ 60000	2000	○	0
F2.16	Torque adjustment integral gain	0~ 60000	0~ 60000	1300	○	0
F2.20	Maximum output voltage coefficient	100~ 110%	100~ 110	105%	◎	0
F2.21	Maximum torque coefficient in the weak magnetic region	50~ 200%	50~ 200%	100%	○	0
F2.22	Generation power limit enables	0: invalid 1: valid	0-1	0	○	0
F2.23	Power cap	Model determination	0~ 200%	100%	○	0
F3 Group V/F Control Parameters						
F3.00	V/F curve setting	0: Line V / F; 1: Multipoint V / F 2: Square V / F; 3:1.2, Secondary V / F 4:1.4, Secondary V / F; 6:1.6, Secondary V / F 8:1.8, Secondary V / F; 9: Keep 10: VF completely separation mode 11: VF, semi-separated mode	0~ 11	0	◎	0
F3.01	Recurrent ascension	0.0%: (Automatic torque increase) 0.1% ~ 30.0%	0.0~30.0	Model determination	○	0
F3.02	Torque lift stop frequency	0.00Hz~ Maximum output frequency	0.00~F.010	50.00Hz	◎	0
F3.03	Multi-point VF frequency point F1	0.00Hz~F3.05	0.00~F3.05	0.00Hz	◎	0
F3.04	Multi-point VF voltage point V1	0.0~100.0%	0.0~100.0	0.0%	◎	0
F3.05	Multi-point VF frequency point F2	F3.03~F3.07	F3.03~F3.07	0.00Hz	◎	0
F3.06	Multi-point VF voltage point V2	0.0~100.0%	0.0~100.0	0.0%	◎	0
F3.07	Multi-point VF frequency point F3	F3.05~ Motor rated frequency (F1.04)	F3.05~F1.04	0.00Hz	◎	0
F3.08	Multi-point VF voltage point V3	0.0~100.0%	0.0~100.0	0.0%	◎	0
F3.09	VF transition compensation gain	0~200.0%	0~200.0	0.0%	○	0

FC	name	Parameters are detailed	Set the scope	default value	change	target
F3.10	VF Overexcitation Gain	0~200	0~200	64	○	0
F3.11	The VF oscillations suppress the gain	0~100	0~100	Model determination	○	0
F3.12	Shock suppression mode selection	Select the shock suppression mode	0~4	3	◎	0
F3.13	The VF-separated voltage source	0: Number Settings (F3.14) 1: VCI 2: CCI 3: The panel potentiometer 4: Pulse setting (X5) 5: Multiple instructions 6: Simple PLC 7: PID 8: Communication given Note: 100.0%, corresponding to the motor rated voltage	0~8	0	○	0
F3.14	VF separation	0V ~ Motor rated voltage	0V ~ Motor rated voltage	0V	○	0
F3.15	Voltage rise time for VF separation	0.0~1000.0s Note: When the 0V changes to the motor rated voltage	0.0~1000.0	0.0s	○	0
F3.16	Voltage drop time for VF separation	0.0~1000.0s Note: When the 0V changes to the motor rated voltage	0.0~1000.0	0.0s	○	0
F3.17	VF separation and shutdown mode selection	0: Frequency / voltage is independently reduced to 0 1: The frequency is reduced after the voltage is reduced to 0	0~1	0	○	0
F3.14	VF separation	0V ~ Motor rated voltage	0V ~ Motor rated voltage	0V	○	0
F3.15	Voltage rise time for VF separation	0.0~1000.0s Note: When the 0V changes to the motor rated voltage	0.0~1000.0	0.0s	○	0
F3.16	Voltage drop time for VF separation	0.0~1000.0s Note: When the 0V changes to the motor rated voltage	0.0~1000.0	0.0s	○	0
F3.17	VF separation and shutdown mode selection	0: Frequency / voltage is independently reduced to 0 1: The frequency is reduced after the voltage is reduced to 0	0~1	0	○	0
F3.18	Over-drain speed action current	50~200%	50~200%	150%		0
F3.19	Excessive loss speed suppression enables	0 Invalid, 1 valid	0~1	1	◎	0
F3.20	Overdrain speed suppression gain	0~100	0~100	20	○	0
F3.21	Compensation coefficient of action current at the excess loss speed	50~200%	50~200%	50%	◎	0

FC	name	Parameters are detailed	Set the scope	default value	change	target
F3.22	Over-voltage stall action voltage	Model determination Three-phase 380-480V model: 330.0V-800.0V Three-phase 200-240V model: 330.0V-800.0V	330.0V-800.0V	Model determination	☉	0
F3.23	Overpressure stall enabling	0 Invalid, 1 valid	0~ 1	1	☉	0
F3.24	Overvoltage stall suppression frequency gain	0~ 100	0~ 100	30	○	0
F3.25	Overvoltage stall suppression voltage gain	0~ 100	0~ 100	30	○	0
F3.26	Maximum rise frequency limit of overvoltage stall	0~ 50Hz	0~ 50	5Hz	☉	0
F3.27	Transfer difference compensation time constant	0.1~ 10.0s	0.1~ 10.0	0.5	○	1
F4 Group Input terminals						
F4.00	The X1 terminal function selection	0: No function 1: OK FWD or OK 2: Invert running REV or reverse direction 3: Three-line operation control 4: Forward rotation (FJOG) 5: Reverse movement (RJOG) 6: Terminal UP 7: Terminal DOWN 8: Free parking 9: Fault reset (RESET) 10: Operation is paused 11: External fault often open input 12: Multiparagraph command terminal 1 13: Multi-segment command terminal 2 14: Multi-segment command terminal 3 15: Multi-segment command terminal 4 16: Increase and deceleration time to select terminal 1 17: Increase and deceleration time to select terminal 2 18: Frequency source switching 19: UP / DOWN, set reset (terminal, keyboard) 20: Control the command to switch over the terminal 1 21: Increase, acceleration and	0~ 59	1	☉	0
F4.01	The X 2 terminal function selection			4	☉	0
F4.02	X 3 terminal function selection			9	☉	0
F4.03	X 4 terminal function selection			12	☉	0
F4.04	X 5 terminal function selection			13	☉	0
F4.05	The X 6 terminal function selection			0	☉	1
F4.06	X 7 terminal function selection			0	☉	1
F4.07	X 8 terminal function selection			0	☉	1

FC	name	Parameters are detailed	Set the scope	default value	change	target
F4.08	X 9 terminal function selection	deceleration 22: The PID is paused 23: The PLC state is reset 24: Sent-out frequency pause 25: Counter input 26: Counter reset 27: Length count input 28: Length reset 29: Torque control is prohibited 30: PULSE (Pulse) frequency input (valid for X5 terminals only) 31: Keep 32: Immediately with DC braking 33: Frequent closed input for external faults 34: Frequency modification enables 35: PID, the direction of action is reversed		0	⊙	1
F4.09	The X 10 terminal function selection	36: External parking terminal 1 37: Control the command to switch over the terminal 2 38: The PID points are suspended 39: Frequency source X and preset frequency switch 40: Switch between the frequency source Y and the preset frequency 41: Motor selection terminal 1 42: Keep 43: PID parameter switching 44: User-defined custom fault 1 45: User-custom fault 2 46: Speed control / torque control switch 47: Emergency stop 48: External parking terminal 2 49: Slow down the DC brake 50: The operation time is cleared to zero	0~59	0	⊙	1
F4.10	DI filtering time	0.000~1.000s	0.000~1.000	0.010s	○	0
F4.11	Terminal command mode	0: Two-line 1 1: Two lines 2 2: Three-line 1 3: Three-line 2	0~3	0	⊙	0
F4.12	Increase rate of terminal UP / DOWN frequency	0.001~65.535Hz/s	0.001~65.535	1.00Hz/s	○	0

FC	name	Parameters are detailed	Set the scope	default value	change	target
F4.13	Simog curve 1 minimum input	0.00V~F4.15	0.00~F4.15	0.00V	○	0
F4.14	The minimum input of analog curve 1 corresponds to the setting	-100.0% ~ +100.0%	-100.0%~ 100.0%	0.0%	○	0
F4.15	Simog curve 1 maximum input	F4.13~10.00V	F4.13~10.00V	10.00V	○	0
F4.16	The maximum input corresponds to the setting	-100.00%~+100.0%	-100.0%~+100.0%	100.0%	○	0
F4.17	VCI input filtering time	0.00~10.00s	0.00~10.00	0.10s	○	0
F4.18	Simulation quantity curve 2 minimum input	0.00V~F4.20	0.00~F4.20	0.00V	○	0
F4.19	The minimum input of the analog quantity curve 2 corresponds to the setting	-100.0% ~ +100.0%	-100.0%~+100.0%	0.0%	○	0
F4.20	Simog curve 2 maximum input	F4.18~10.00V	F4.18~10.00V	10.00V	○	0
F4.21	The maximum input corresponds to the setting	-100.00%~+100.0%	-100.0%~+100.0%	100.0%	○	0
F4.22	CCI input filtering time	0.00~10.00s	0.00~10.00	0.10s	○	0
F4.23	Simulated quantity curve 3 minimum input	0.00V~F4.25	0.00~F4.25	-10.00V	○	0
F4.24	The minimum input of analog curve 3 corresponds to the setting	-100.0% ~ +100.0%	-100.0%~100.0%	-100.0%	○	0
F4.25	Simog curve 3 maximum input	F4.23~10.00V	F4.23~10.00V	10.00V	○	0
F4.26	The maximum input of the analog quantity curve 3 corresponds to the setting	-100.00%~+100.0%	-100.0%~+100.0%	100.0%	○	0
F4.27	Panel potentiometer input filter time	0.00~10.00s	0.00~10.00	0.10s	○	0
F4.28	X5 terminal minimum frequency	0.00kHz~F4.30	0.00~F4.30	0.00kHz	○	0
F4.29	The minimum frequency of the X5 terminal corresponds to the setting	-100.0% ~ +100.0%	-100.0%~+100.0%	0.0%	○	0
F4.30	The X5 terminal maximum frequency	F4.28~20.00kHz	F4.28~20.00kHz	20.00kHz	○	0
F4.31	The maximum frequency of the X5 terminal corresponds to the setting	-100.00%~+100.0%	-100.0%~+100.0%	100.0%	○	0
F4.32	The X5 terminal frequency input filter time	0.00~10.00s	0.00~10.00	0.10s	○	0
F4.33	Simulation quantity curve selection	Individual bit: VCI curve selection 1: Curve 1 (2 points, see F4.13~F4.16)	0~5	321	○	0

FC	name	Parameters are detailed	Set the scope	default value	change	target
		2: Curve 2 (2 points, see F4.18~F4.21) 3: Curve 3 (2 points, see F4.23~F4.26) 4: Curve 4 (4 points, see A6.00~A6.07) 5: Curve 5 (4 points, see A6.08~A6.15) Ten places: CCI curve selection, ibid to above Hundred bits: panel potentiometer curve selection, same to above				
F4.34	The simulation volume is below the minimum input setting selection	Individual bit: The VCI is below the minimum input setting selection 0: Corresponding to the minimum input setting; 1:0.0% Ten digits: The CCI is below the minimum input setting selection, ibid Hundred bits: panel potentiometer below the minimum input setting selection, as above	0~5	000	○	0
F4.35	X1 Delay Time	0.0~3600.0s	0.0~3600.0	0.0s	◎	0
F4.36	X2 Delay Time	0.0~3600.0s	0.0~3600.0	0.0s	◎	0
F4.37	X3 Delay Time	0.0~3600.0s	0.0~3600.0	0.0s	◎	0
F4.38	The X-terminal valid mode selection is 1	0: Effective at a high power level 1: Effective at the low level One: X1; ten: X2; one hundred: X3 Thousand: X4; ten thousand: X5	0~1	00000	◎	0
F4.39	The X-terminal valid mode selection is 2	0: Effective at a high power level 1: Effective at the low level One: X6; ten: X7; one hundred: X8 Thousand: X9; ten thousand: X10	0~1	00000	◎	0
F5 Group Output Terminals						
F5.00	DO terminal output mode selection	0: High speed pulse output of open collector: the highest pulse frequency is 100.00kHz. See F5.06 for related functions; 1: Open circuit collector output: see F5.01 for related functions	0~1	0	◎	0
F5.01	DO function selection (collector open-circuit output terminal)	0: No output 1: frequency converter in operation 2: Fault output (fault for free	0~ 41	0	○	0

FC	name	Parameters are detailed	Set the scope	default value	change	target
F5.02	Relay output function selection (TA-TB-TC)	shutdown fault) 3: The FDT1 output is detected by the frequency level 4: Frequency arrives	0~ 41	2	○	0
F5.03	Expansion Card Relay Output Function Selection (TA1-TB1-TC1)	5: Zero-speed operation (no output during shutdown) 6: Motor overload forecast alarm 7: frequency converter overload forecast alarm		0	○	0
F5.04	DO1 output function selection (collector open circuit output terminal)	8: Set the record value and arrived 9: Specify that the marked value arrives 10: Length reached		1	○	1
F5.05	Expansion card DO2, the output function selection	11: The PLC cycle is completed 12: Accumulated running time for arrival 13: Frequency limit is in the middle 14: Torque limit in 15: Ready to run 16: VCI>CCI 17: Upper bound frequency reaches 18: Lower limit frequency reached (operation related) 19: Undervoltage state output 20: Communication settings 21: Location completed (reserved) 22: Positioning close (reserved) 23: Zero-speed operation 2 (also output when shutdown) 24: Accumulated power supply time arrives 25: FDT2 output 26: Frequency 1 reaches the output 27: Frequency 2 reaches the output 28: Current 1 reaches the output 29: Current 2 reaches the output 30: Regular arrival of the output 31: The VCI input is overrun 32: In the load 33: Reverse operation is in operation 34: Zero current state 35: The module temperature arrives 36: Output current limit 37: Lower frequency reached (shutdown also output)		4	○	1

FC	name	Parameters are detailed	Set the scope	default value	change	target
		38: Warning output (all faults) 39: Motor over-temperature forecast alarm 40: The running time arrives 41: Fault output (for free shutdown fault and underpressure is not output)				
F5.06	DO open-circuit collector electrode high-speed pulse output selection	0: Run frequency 1: Set the frequency 2: Output current 3: Motor output torque (absolute value, 0 ~ 142. relative motor)	0~ 17	0	○	0
F5.07	AO1 output selection	4: Output power		0	○	0
F5.08	AO2 output selection	5: Output voltage 6: DI input (100.0% corresponding to 100.0kHz) 7: VCI 8: CCI 9: Panel potentiometer 10: Length 11: Remember the value 12: Communication setting 13: Motor rotation speed 14: Output current (100.0% corresponding to 1000.0A) 15: Output voltage (100.0% corresponding to 1000.0V) 16: Motor output torque (actual value, percentage relative to motor) 17: Output torque (actual value, percentage relative to frequency converter)		1	○	0
F5.09	DO output maximum frequency	0.01~20.00kHz	0.01~20.00	20.00kHz	○	0
F5.10	AO1 zero-bias coefficient	-100.0% ~ +100.0%	-100.0% ~ +100.0%	0.0%	○	0
F5.11	AO1 gain	-10.00 ~ +10.00	-10.00~+10.00	1.00	○	0
F5.12	AO2 zero-bias coefficient	-100.0% ~ +100.0%	-100.0% ~ +100.0%	0.0%	○	0
F5.13	Expansion Card AO2 Gain	-10.00 ~ +10.00	-10.00~+10.00	1.00	○	0
F5.17	Switch volume output delay time for the collector open circuit	0.0~3600.0s	0.0~3600.0	0.0s	○	0
F5.18	The RELAY1 output delay time	0.0~3600.0s	0.0~3600.0	0.0s	○	0
F5.19	The RELAY2 output delay time	0.0~3600.0s	0.0~3600.0	0.0s	○	0

FC	name	Parameters are detailed	Set the scope	default value	change	target
F5.20	DO1 output delay time	0.0~3600.0s	0.0~3600.0	0.0s	○	0
F5.21	DO2 output delay time	0.0~3600.0s	0.0~3600.0	0.0s	○	0
F5.22	DO output terminal Valid State Selection	0: Positive logic 1: Anti-logic the unit:DO Ten places: RELAY1 Hundred bits: RELAY2 Thousand position: DO1 Ten thousand positions: DO2	0~1	00000	○	0
F6 Group Start and stop						
F6.00	Start stop mode	0: Direct start 1: Speed tracking and restart 2: Pre-excitation start (AC asynchronous machine) 3: SVC quick start	0~3	0	○	0
F6.01	Speed tracking method	0: Start with the shutdown frequency 1: Start with the power frequency 2: Start with the maximum frequency	0~2	0	◎	0
F6.02	Speed tracking fast and slow	1~100	1~100	20	○	0
F6.03	Direct start start frequency	0.00~10.00 Hz	0.00~10.00	0.00Hz	○	0
F6.04	Startup frequency retention time	0.0 ~100.0s	0.0 ~100.0	0.0s	◎	0
F6.05	Start-front brake current	0~100%	0~100%	0%	◎	0
F6.06	Brake time before starting	0.0~100.0s	0.0~100.0	0.0s	◎	0
F6.07	Increase and deceleration mode selection	0: Straight-line acceleration and deceleration 1: Static S-curve 2: Dynamic S-curve	0~2	0	◎	0
F6.08	S curve start time scale	0.0% ~ (70.0%-F6.09)	0.0% ~ (70.0%-F6.09)	30%	◎	0
F6.09	S-curve end period time scale	0.0% ~ (70.0%-F6.09)	0.0% ~ (70.0%-F6.09)	30%	◎	0
F6.10	Stop mode selection	0: Slow down parking, 1: Free parking	0~1	0	○	0

FC	name	Parameters are detailed	Set the scope	default value	change	target
F6.11	Stop the brake start frequency	0.00Hz ~F0.10	0.00Hz~F0.10	0.00Hz	○	0
F6.12	Stop the brake waiting time	0.0~100.0s	0.0~100.0	0.0s	○	0
F6.13	Stop the DC brake current	0.0~100.0%	0.0~100.0%	0%	○	0
F6.14	Stop the DC brake time	0.0~100.0s	0.0~100.0	0.0s	○	0
F6.15	Brake utilization rate	0.0~100.0%	0.0~100.0%	100.0%	○	0
F6.18	Speed tracking current	30~200%	30~200%	Model determination	◎	0
F6.21	Demagnetic time	0.0~5.0s	0.0~5.0	Model determination	◎	0
F7 Group Operation Panel and Display						
F7.00	Digital pipe lack drawing inspection enables	0~ 1	0~ 1	0	○	0
F7.01	The MJOG key function selection	0: Invalid MJOG 1: The operation panel command channel switches to the remote command channel (terminal command channel or communication command channel) 2: Forward and reverse switch 3: Positive point movement 4: Reverse point movement	0~ 4	0	◎	0
F7.02	STOP / RST key Shutdown function selection	0: The STOP / RST key shutdown function is valid only in the keyboard operation mode 1: The STOP / RST key shutdown function is valid in any operation mode	0~ 1	1	○	0
F7.03	The parameter selection displayed by the running status is 1	0000~FFFF Bit00: Operating frequency 1 (Hz) Bit01: Set Frequency (Hz) Bit02:, Bus line voltage (V) Bit03:, Output voltage (V) Bit04:, Output current (A) Bit05: output power (kW) Bit06:, Output torque, (%) Bit07: The X terminal input state Bit08: DO output status Bit09: VCI voltage (V) Bit10: CCI voltage (V) Bit11: Panel potentiometer voltage (V) Bit12: Count value	0000~FFFF	001F	○	0

FC	name	Parameters are detailed	Set the scope	default value	change	target
		Bit13: Length value Bit14: Load speed display Bit15: PID setting				
F7.04	The parameter selection displayed by the running status is 2	0000~FFFF Bit00:PID feedback Bit01: The PLC stage Bit02: X5 terminal input pulse frequency (kHz) Bit03: Operating frequency 2 (Hz) Bit04: Remaining running time Bit05: VCI correction front voltage (V) Bit06: CCI correction front voltage (V) Bit07: Panel potentiometer correction front voltage (V) Bit08: Line speed Bit09: Current Power Time (Hour) Bit10: Current running time (Min) Bit11: X5 terminal input pulse frequency (Hz) Bit12: Communication Setpoint Bit13: Encoder feedback speed (Hz) Bit14: Main frequency X display (Hz) Bit15: Auxiliary frequency Y display (Hz)	0000~FFFF	0000	◎	0
F7.05	Parameter selection for the downtime state display	0000~FFFF Bit00: Set Frequency (Hz) Bit01: Bus line voltage (V) Bit02: DI input status Bit03: DO output status Bit04: VCI voltage (V) Bit05: CCI voltage (V) Bit06: Panel potentiometer voltage (V) Bit07: Count value Bit08: Length value Bit09: The PLC stage Bit10: Load speed Bit11: The PID setting Bit12: X5 terminal input pulse frequency (kHz)	0000~FFFF	0033	◎	0
F7.06	Speed display coefficient	0.0001~6.5000	0.0001~6.5000	1.0000	○	0
F7.07	IGBT heat sink temperature	-20℃~120.0℃	-	-20℃	●	0

FC	name	Parameters are detailed	Set the scope	default value	change	target
F7.08	Product number	-	-	-	●	0
F7.09	Cumulative running time	0~65535h	0~65535	0h	●	0
F7.10	Performance version number	-	-	-	●	0
F7.11	Functional version number	-	-	-	●	0
F7.12	Load speed shows decimal digits	Individual bit: the number of decimal points of U0-14 The 0:0 decimal places The 1:1 decimal place At 2:2 decimal places In the 3:3 decimal places Ten places: U0-19 / U0-29 decimal points The 1:1 decimal place At 2:2 decimal places	0~3	21	○	0
F7.13	Cumulative power time	0~65535h	-	-	●	0
F7.14	Accumulated power consumption	0~65535KWH	-	-	●	0
F7.15	Performance Temporary Software Version No	-	-	-	●	0
F7.16	Functional temporary software version number	-	-	-	●	0
F8 Group Enhanced Function						
F8.00	Inch operation frequency	0.00~F0.10 (Maximum frequency)	0.00~F0.10	2.00Hz	○	0
F8.01	Inched acceleration time	0.0~6500.0s	0.0~6500.0	20s	○	0
F8.02	Inched deceleration time	0.0~6500.0s	0.0~6500.0	20s	○	0
F8.03	Acceleration time 2	0.0~6500.0s	0.0~6500.0	Model determination	○	0
F8.04	Slow down time 2	0.0~6500.0s	0.0~6500.0	Model determination	○	0
F8.05	Acceleration time 3	0.0~6500.0s	0.0~6500.0	Model determination	○	0
F8.06	Slow down time 3	0.0~6500.0s	0.0~6500.0	Model determination	○	0
F8.07	Acceleration time 4	0.0~6500.0s	0.0~6500.0	Model determination	○	0
F8.08	Slow down time 4	0.0~6500.0s	0.0~6500.0	Model determination	○	0

FC	name	Parameters are detailed	Set the scope	default value	change	target
F8.09	Jump frequency 1	0.00Hz~F0.10 (Maximum frequency)	0.00~F0.10	0.00Hz	○	0
F8.10	Jump frequency 2	0.00Hz~F0.10 (Maximum frequency)	0.00~F0.10	0.00Hz	○	0
F8.11	Jump frequency amplitude	0.00Hz~F0.10 (Maximum frequency)	0.00~F0.10	0.01Hz	○	0
F8.12	Reverse the dead zone time	0.0~3000.0s	0.0~3000.0	0.0s	○	0
F8.13	Reverse frequency prohibited	0: Invalid, 1: valid	0~1	0	○	0
F8.14	Set the frequency is below the lower limit frequency operating mode	0: Run at the lower limit frequency 1: Downtime 2: Zero speed operation	0~2	0	○	0
F8.15	The sagging rate	0.00~10%	0.00~10.00	0.00%	○	0
F8.16	Set the cumulative power arrival time	0~65000h	0~65000	0h	○	0
F8.17	Sets the cumulative run arrival time	0~65000h	0~65000	0h	○	0
F8.18	Start protection options	0: No protection 1: Protection	0~1	0	○	0
F8.19	Frequency detection value 1	0.00Hz ~F0.10 (Maximum frequency)	0.00Hz ~F0.10	050.00Hz	○	0
F8.20	Frequency detection lag rate 1	0.0~100.0%	0.0~100.0%	5.0%	○	0
F8.21	Frequency reaches the detection amplitude	0.0~100.0% (Maximum frequency)	0.0~100.0%	0.0%	○	0
F8.22	Jumping frequency during the acceleration and deceleration process Whether effective	0: Invalid, 1: valid	0~1	0	○	0
F8.25	Acceleration time of 1, compared with the acceleration time 2. Switch over the frequency points	0.00Hz ~F0.10 (Maximum frequency)	0.00Hz ~F0.10	0.00Hz	○	0
F8.26	Switch the frequency points between deceleration time 1 and deceleration time 2	0.00Hz ~F0.10 (Maximum frequency)	0.00Hz ~F0.10	0.00Hz	○	0
F8.27	Terminal point motion is preferred	0: Invalid, 1: valid	0~1	0	○	0
F8.28	Frequency detection value 2	0.00Hz ~F0.10 (Maximum frequency)	0.00~F0.10	50.00Hz	○	0
F8.29	Frequency detection lag value of 2	0.0~100.0%	0.0~100.0%	5.0%	○	0
F8.30	Arbitrary arrival frequency detection value of 1	0.00Hz ~F0.10 (Maximum frequency)	0.00~F0.10	50.00Hz	○	0

FC	name	Parameters are detailed	Set the scope	default value	change	target
F8.31	Arbitrary arrival frequency detection width of 1	0.0~100.0%	0.0~100.0%	0.0%	○	0
F8.32	Arbitrary arrival frequency detection value 2	0.00Hz ~F0.10 (Maximum frequency)	0.00~F0.10	50.00Hz	○	0
F8.33	Any arrival frequency detection width 2	0.0~100.0%	0.0~100.0%	0.0%	○	0
F8.34	Zero-current detection level	0.0~300.0% 100.0% corresponds to the motor rated current	0.0~300.0%	5.0%	○	0
F8.35	Zero-current detection delay time	0.00~600.00s	0.00~600.00	0.10s	○	0
F8.36	Output current limit value	0.0% (Undetected) 0.1~300.0% (Motor rated current)	0.0~300.0%	200.0%	○	0
F8.37	Output current overrun detection delay time	0.00~600.00s	0.00~600.00	0.0s	○	0
F8.38	Any reach current 1	0.0~300.0% (rated current of the motor)	0.0~300.0%	100.0%	○	0
F8.39	Any reach current 1 width	0.0~300.0% (rated current of the motor)	0.0~300.0%	0.0%	○	0
F8.40	Any reach current 2	0.0~300.0% (rated current of the motor)	0.0~300.0%	100.0%	○	0
F8.41	Any reach current 2 width	0.0~300.0% (rated current of the motor)	0.0~300.0%	0.0%	○	0
F8.42	Time function selection	0: Invalid 1: valid	0~1	0	◎	0
F8.43	Timrunning time selection	0: F8.44 Settings 1: VCI 2: CCI3: The panel potentiometer The simulated input range corresponds to F8.44	0~3	0	◎	0
F8.44	Time running time	0.0~6500.0Min	0.0~6500.0	0.0Min	◎	0
F8.45	Lower limit of VCI input voltage protection value	0.0V~F8.46	0.0V~F8.46	3.10V	○	0
F8.46	VCI input voltage protection cap	F8.45~11.0V	F8.45~11.0V	6.80V	○	0
F8.47	Module temperature arrives	0~100℃	0~100℃	75℃	○	0
F8.48	Heat dissipation fan control	0: The fan operates during operation 1: The fan is always running	0~1	0	○	0
F8.49	Wake up frequency	F8.51~ F0.10	F8.51~ F0.10	0.00Hz	○	0
F8.50	Wake up delay time	0.0~6500.0s	0.0~6500.0	0.0s	○	0

FC	name	Parameters are detailed	Set the scope	default value	change	target
F8.51	The dormancy frequency	0.00Hz~F8.49	0.00Hz~F8.49	0.00Hz	○	0
F8.52	Sleep delay time	0.0~6500.0s	0.0~6500.0	0.0s	○	0
F8.53	Arrival time of this operation	0.0~6500.0Min	0.0~6500.0	0.0Min	○	0
F8.54	Output power correction coefficient	0.0~200.0%	0.0~200.0%	100.0%	○	0
F9 Group Fault and protection						
F9.00	Motor overload protection selection	0: Prohibited, 1: Allow	0~1	1	○	0
F9.01	Motor overload protection gain	0.20~10.00	0.20~10.00	1.00	○	0
F9.02	Motor overload early warning factor	50.0~120.0%	50.0~120.0%	80.0%	○	0
F9.03	Overpressure stall gain	0-100	0-100	30	○	0
F9.04	Over-voltage stall protection voltage	650V-800V	650V-800V	760V	○	0
F9.07	Short-circuit-to-ground protection option	Individual bit: upper power short circuit to ground protection selection 0: Invalid, 1: valid Ten place: power to short circuit to ground protection choice 0: Invalid, 1: valid				0
F9.08	Brake unit action start voltage	Three-phase 380-480V model: 320.0V-800.0V Three-phase 200-240V model: 320.0V-800.0V	320.0V-800.0V	760V	○	0
F9.09	Number of automatic reset times of failures	0~20	0~20	0	○	0
F9.10	Fault DO action selection during the automatic fault reset	0: No action 1: Action	0~1	0	○	0
F9.11	Automatic fault reset interval time	0.1~100.0s	0.1~100.0	1.0s	○	0
F9.12	Enter the phase absence \ contactor suction protection selection	Individual bit: Enter the missing phase protection selection Ten place: contactor suction protection selection 0: Prohibit 1: Allow	0~1	11	○	0
F9.13	Output the missing phase protection selection	Individual bit: Output the missing phase protection selection 0: Prohibited, 1: Allow Ten digits: the output is missing phase protection selection	0~1	1	○	0

FC	name	Parameters are detailed	Set the scope	default value	change	target
		before operation 0: Prohibited, 1: Allow				
F9.14	First-time failure type	0: No fault 1: Keep	-100.0~100.0	0.0%	●	0
F9.15	Second failure type	2: Accelerated overcurrent 3: Slow down the overcurrent	0.0~6553.5	0.0s	●	0
F9.16	Third time (most recent) fault type	4: Constant-speed over-current 5: Accelerated overvoltage 6: Reduced-down overvoltage 7: Constant speed overvoltage 8: Buffer resistance to overload 9: Underpressure 10: frequency converter overload 11: Motor overload 11: Motor overload 12: Enter the missing phase 13: Output phase absence 14: The module is overheated 15: External fault 16: Special communication exception 17: The Contactor is abnormal 18: Abnormal current detection 19: Abnormal motor tuning 20: Encoder / PG card exception 21: parameter read and write exception 22: The frequency converter hardware is abnormal 23: Motor short-circuit to the ground 24: Keep 25: Keep 26: Runtime arrival 27: User-custom fault 1 28: User-defined custom fault 2 29: Power-on time arrives 30: Loading 31: Runtime PID feedback is lost 40: Fast flow limit timeout 41: Switch the motor during operation 42: Speed deviation is too large 43: Motor overspeed 45: Motor overtemperature 51: Initial position is incorrect 55: Load distribution slave fault	-100.0~100.0	0.0%	●	0

FC	name	Parameters are detailed	Set the scope	default value	change	target
F9.17	Frequency at the third (latest) failure	—	—	—	●	0
F9.18	Current at the third (most recent) fault	—	—	—	●	0
F9.19	Bus voltage at the third (most recent) fault	—	—	—	●	0
F9.20	Enter the terminal status for the third (latest) failure	—	—	—	●	0
F9.21	Output terminal status at the third (latest) failure	—	—	—	●	0
F9.22	Frequency status during the third (latest) failure	—	—	—	●	0
F9.23	Power time during the third (most recent) failure	—	—	—	●	0
F9.24	Running time for the third (most recent) failure	—	—	—	●	0
F9.27	Second fault time and frequency	—	—	—	●	0
F9.28	Current at the second fault	—	—	—	●	0
F9.29	Bus voltage at the second fault	—	—	—	●	0
F9.30	Input the terminal status for the second fault	—	—	—	●	0
F9.31	Output terminal status at the second failure	—	—	—	●	0
F9.32	The converter status during the second failure	—	—	—	●	0
F9.33	Power-on time during the second failure	—	—	—	●	0
F9.34	Running time for the second failure	—	—	—	●	0
F9.37	Frequency at the first failure	—	—	—	●	0
F9.38	Current at the first failure	—	—	—	●	0
F9.39	Bus voltage at the first fault	—	—	—	●	0
F9.40	Enter the terminal status for the first failure	—	—	—	●	0
F9.41	Output terminal status at the first failure	—	—	—	●	0
F9.42	Frequency status during the first failure	—	—	—	●	0

FC	name	Parameters are detailed	Set the scope	default value	change	target
F9.43	Power-on time during the first failure	—	—	—	●	0
F9.44	Run time on the first failure	—	—	—	●	0
F9.47	Fault protection action selection 1	Individual bit: motor overload (11) 0: Free parking 1: Stop down by shutdown mode 2: Continue running Ten digit: input of missing phase (12) Hundred bits: output phase absence (13) Thousand bits: external fault (15) Ten thousand bits: abnormal communication (16)	0~ 2	00000	○	0
F9.48	Fault protection action selection 2	Individual bit: Encoder / PG card exception (20) 0: Free parking Ten digits: abnormal function code reading and writing (21) 0: Free parking 1: Stop down by shutdown mode Hundred bits: frequency converter overload fault action selection (Error10): 0: Free shutdown, 1: reduced operation Thousand: Motor Overheat (25) Ten thousand bits: running time arrival (26)	0~ 1	00000	○	0
F9.49	Fault protection action selection 3	Individual bit: User-custom fault 1 (27) 0: Free parking 1: Stop down by shutdown mode 2: Continue running Ten digit: User custom fault 2 (28) 0: Free parking 1: Stop down by shutdown mode 2: Continue running Hundred bits: power-on time arrival (29) 0: Free parking 1: Stop down by shutdown mode 2: Continue running	0~ 2	00000	○	0

FC	name	Parameters are detailed	Set the scope	default value	change	target
		Thousand: drop (30) 0: Free parking 1: Slow down and stop 2: Jump directly to the rated frequency of the motor 7% Continue to run, no load drop since Move back to the set frequency to run Ten: Runtime PID feedback loss (31) 0: Free parking 1: Stop down by shutdown mode 2: Continue running				
F9.50	Fault protection action selection 4	Individual bits: excessive speed deviation (42) 0: Free parking fault protection 1: Stop down by shutdown mode 2: Continue running Ten-place: motor overspeed (43) Hundred bits: initial position error (51)	0~2	00000	○	0
F9.54	Continue running frequency selection when failure	0: Run at the current operating frequency 1: Run at a set frequency 2: Above limit frequency operation 3: Run at the lower limit frequency 4: Run at an abnormal standby frequency	0~4	0	○	0
F9.55	Abnormal backup frequency	The frequency of 0.0% corresponds to a maximum frequency of ~100.0% (100.0% F0.10)	0.0%~100.0%	100.0%	○	0
F9.56	Motor temperature sensor type	0: No temperature sensor 1: PT100 2: PT1000	0~2	0	○	0
F9.57	Motor overheat protection threshold	0°C~200°C	0°C~200°C	110°C	○	0
F9.58	Motor overheating forecast alarm threshold	0°C~200°C	0°C~200°C	90°C		0
F9.59	Instant stop stop stop function selection	0: invalid 1: Slow down 2: Slow down	0~2	0	◎	0
F9.60	The transient stop action stops the judging voltage	80.0%~100.0%	80.0%~100.0%	85.0%	◎	0
F9.61	Insient stop and non-stop voltage recovery judgment time	0.0~100.0s	0.0~100.0	0.5s	◎	0

FC	name	Parameters are detailed	Set the scope	default value	change	target
F9.62	Determine the voltage by instantaneous stop	60~100% (Standard bus voltage)	60~100%	80.0%	○	0
F9.63	Loading protection options	0: Invalid, 1: valid	0~1	0	○	0
F9.64	Desload detection level	0.0~100.0%	0.0~100.0%	10%	○	0
F9.65	Deload detection time	0.0~60.0s	0.0~60.0	1.0s	○	0
F9.67	Overspeed detection value	0.0~50.0% (Maximum frequency)	0.0~50.0%	20%	○	0
F9.68	Overspeed detection time	0.0s: Non-detection, 0.1~60.0s	0.0~60.0	1.0s	○	0
F9.69	Excessive velocity deviation	0.0~50.0% (Maximum frequency)	0.0~50.0%	20%	○	0
F9.70	Too large speed deviation and too large detection time	0.0s: Non-detection, 0.1~60.0s	0.0~60.0	5.0s	○	0
F9.71	Instant stop stop gain Kp	0~100	0.0~100	40	○	0
F9.72	Instsient stop integral coefficient Ki	0~100	0.0~100	30	○	0
F9.73	Insient stop, non-stop action and deceleration time	0~300.0s	0~300.0s	20.0s	◎	0
FA Group Process Control PID Function						
FA.00	PID, given the source	0: FA-01 setting 1: VCI 2: CCI 3: Panel potentiometer 4: X5 terminal pulse setting 5: Communication given 6: Multiple instructions are given	0~6	0	○	0
FA.01	The PID values are given for the following time	0.0~100.0%	0.0~100.0%	50.0%	○	0
FA.02	The PID, the feedback source	0: VCI 1: CCI 2: Panel potentiometer 3: VCI-CCI 4: High-speed pulse X5 5: Communication 6: VCI+CCI 7: Max(VCI,CCI) 8: Min(VCI,CCI)	0~8	0	○	0
FA.03	PID application direction	0: Positive action; 1: reverse reaction	0~1	0	○	0

FC	name	Parameters are detailed	Set the scope	default value	change	target
FA.04	The PID is given to the feedback range	0~65535	0~65535	1000	○	0
FA.05	Proportional gain of Kp1	0.0~100.0	0.0~100.0	20.0	○	0
FA.06	Integral time, Ti1	0.01~10.00s	0.01~10.00	2.00s	○	0
FA.07	Differential time, Td1	0.01~10.00s	0.00~10.00	0.00s	○	0
FA.08	PID Reverse cutoff frequency	0.00Hz ~F0.10	0.00Hz ~F0.10	2.00Hz	○	0
FA.09	The PID deviation limit	0.0~100.0%	0.0~100.0%	0.0%	○	0
FA.10	PID differential limit amplitude	0.00~100.00%	0.00~100.00%	0.1%	○	0
FA.11	PID given change time	0.00~650.00s	0.00~650.00	0.00s	○	0
FA.12	PID feedback filtering time	0.00~60.00s	0.00~60.00	0.00s	○	0
FA.13	The PID output filtering time	0.00~60.00s	0.00~60.00	0.00s	○	0
FA.14	continue to have	—	—	—	○	0
FA.15	Proportional gain of Kp2	0.0~1000.0	0.0~1000.0	20.0	○	0
FA.16	Integration time Ti2	0.01~10.00s	0.01~10.00	2.00s	○	0
FA.17	Differential time, Td2	0.000~10.000s	0.000~10.000	0.000s	○	0
FA.18	The PID parameter switching condition	0: Don't switch 1: Switch through the X terminal 2: Automatic switch according to the deviation 3: Automatic switch according to the operating frequency	0~3	0	○	0
FA.19	The PID parameter switching deviation 1	0.0%~FA.20	0.0%~FA.20	20.0%	○	0
FA.20	The PID parameter switching deviation 2	FA.19~100.0%	FA.19~100.0%	80.0%	○	0
FA.21	PID starter	0.0~100.0%	0.0~100.0%	0.0%	○	0
FA.22	PID initial value retention time	0.00~650.00s	0.00~650.00	0.00s	○	0
FA.23	Two output deviation positive maximum values	0.00~100.0%	0.00~100.0%	1.00%	○	0
FA.24	Two output deviation reverse maximum	0.00~100.0%	0.00~100.0%	1.00%	○	0

FC	name	Parameters are detailed	Set the scope	default value	change	target
FA.25	The PID integral attribute	Individual bit: integral separation 0: Invalid; 1: valid Ten digits: whether to stop the integration after the output to the limit 0: Continue points; 1: Stop the points	0~1	00	○	0
FA.26	PID feedback loss detection value	0.0%: Do not judge the missing feedback 0.1% ~ 100.0%	0.0~100.0%	0.0%	○	0
FA.27	PID feedback on loss of detection value time	0.0~20.0s	0.0~20.0	0.0s	○	0
FA.28	The PID shutdown operation	0: Stop and do not operate 1: Downtime operation	0~1	0	○	0
FB Group Swing Frequency,Fixed Length and Count						
FB.00	Layout setting method	0: Relative to the center frequency 1: Relative to the maximum frequency	0~1	0	○	0
FB.01	The frequency amplitude	0.0~100.0%	0.0~100.0%	0.0%	○	0
FB.02	The amplitude of the jump frequency	0.0~50.0%	0.0~50.0%	0.0%	○	0
FB.03	Pop frequency cycle	0.0~3000.0s	0.0~3000.0	10.0s	○	0
FB.04	Time coefficient of triangular wave rise	0.0~100.0%	0.0~100.0%	50.0%	○	0
FB.05	Set the length	0~65535m	0~65535	1000m	○	0
FB.06	physical length	0~65535m	0~65535	0m	○	0
FB.07	Pulse number per meter	0.1~6553.5	0.1~6553.5	100.0	○	0
FB.08	Set the gauge value	1~65535	1~65535	1000	○	0
FB.09	Specify the count value	1~65535	1~65535	1000	○	0
FC Group Multi-Speed and Simple PLC Function						
FC.00	Multi-segment speed 0	-100.0~100.0%	-100.0~100.0%	0.0%	○	0
FC.01	Multi-segment speed 1	-100.0~100.0%	-100.0~100.0%	0.0%	○	0
FC.02	Multi-segment speed 2	-100.0~100.0%	-100.0~100.0%	0.0%	○	0

FC	name	Parameters are detailed	Set the scope	default value	change	target
FC.03	Multi-segment speed 3	-100.0~100.0%	-100.0~100.0%	0.0%	○	0
FC.04	Multi-segment speed 4	-100.0~100.0%	-100.0~100.0%	0.0%	○	0
FC.05	Multi-segment speed 5	-100.0~100.0%	-100.0~100.0%	0.0%	○	0
FC.06	Multi-segment speed 6	-100.0~100.0%	-100.0~100.0%	0.0%	○	0
FC.07	Multi-segment speed 7	-100.0~100.0%	-100.0~100.0%	0.0%	○	0
FC.08	Multi-segment speed 8	-100.0~100.0%	-100.0~100.0%	0.0%	○	0
FC.09	Multi-segment speed 9	-100.0~100.0%	-100.0~100.0%	0.0%	○	0
FC.10	Multi-segment speed 10	-100.0~100.0%	-100.0~100.0%	0.0%	○	0
FC.11	Multi-segment speed 11	-100.0~100.0%	-100.0~100.0%	0.0%	○	0
FC.12	Multi-segment speed 12	-100.0~100.0%	-100.0~100.0%	0.0%	○	0
FC.13	Multi-section speed 13	-100.0~100.0%	-100.0~100.0%	0.0%	○	0
FC.14	Multi-segment speed 14	-100.0~100.0%	-100.0~100.0%	0.0%	○	0
FC.15	Multi-segment speed 15	-100.0~100.0%	-100.0~100.0%	0.0%	○	0
FC.16	Simple PLC operation mode	0: Stop after the end of a single operation 1: Final value is maintained at the end of a single run 2: Always cycle	0~ 2	0	○	0
FC.17	Simple PLC power loss memory selection	Individual bit: power loss memory selection 0: Do not remember the power loss 1: ELECTRIC memory Ten places: Stop memory selection 0: Stop without remember 1: Stop memory	0~ 1	00	○	0
FC.18	Easy PLC segment 0 run time	0~6500.0s(h)	0~6500.0s	0.0s(h)	○	0
FC.19	Simple PLC segment 0 acceleration and deceleration time	0~3	0~3	0	○	0
FC.20	Simple PLC segment 1 runtime	0~6500.0s(h)	0~6500.0s	0.0s(h)	○	0
FC.21	Simple PLC paragraph 1 acceleration and	0~3	0~3	0	○	0

FC	name	Parameters are detailed	Set the scope	default value	change	target
	deceleration time					
FC.22	Simple PLC segment 2 runtime	0~6500.0s(h)	0~6500.0s	0.0s(h)	○	0
FC.23	Simple PLC segment 2 acceleration and deceleration time	0~3	0~3	0	○	0
FC.24	Simple PLC segment 3 running time	0~6500.0s(h)	0~6500.0s	0.0s(h)	○	0
FC.25	Simple PLC paragraph 3 acceleration and deceleration time	0~3	0~3	0	○	0
FC.26	Simple PLC segment 4 running time	0~6500.0s(h)	0~6500.0s	0.0s(h)	○	0
FC.27	Simple PLC segment 4 acceleration and deceleration time	0~3	0~3	0	○	0
FC.28	Simple PLC segment 5 run time	0~6500.0s(h)	0~6500.0s	0.0s(h)	○	0
FC.29	Simple PLC segment 5 acceleration and deceleration time	0~3	0~3	0	○	0
FC.30	Simple PLC segment 6 running time	0~6500.0s(h)	0~6500.0s	0.0s(h)	○	0
FC.31	Simple PLC segment 6 acceleration and deceleration time	0~3	0~3	0	○	0
FC.32	Simple PLC segment 7 runtime	0~6500.0s(h)	0~6500.0s	0.0s(h)	○	0
FC.33	Simple PLC segment 7 acceleration and deceleration time	0~3	0~3	0	○	0
FC.34	Easy PLC segment 8 running time	0~6500.0s(h)	0~6500.0s	0.0s(h)	○	0
FC.35	Simple PLC segment 8 acceleration and deceleration time	0~3	0~3	0	○	0
FC.36	Simple PLC segment 9 runtime	0~6500.0s(h)	0~6500.0s	0.0s(h)	○	0
FC.37	Simple PLC paragraph 9 acceleration and deceleration time	0~3	0~3	0	○	0
FC.38	Easy PLC segment 10 running time	0~6500.0s(h)	0~6500.0s	0.0s(h)	○	0
FC.39	Simple PLC paragraph 10 acceleration and deceleration time	0~3	0~3	0	○	0
FC.40	Easy PLC segment 11 running time	0~6500.0s(h)	0~6500.0s	0.0s(h)	○	0
FC.41	Simple PLC paragraph 11 acceleration and deceleration time	0~3	0~3	0	○	0

FC	name	Parameters are detailed	Set the scope	default value	change	target
FC.42	Simple PLC period 12 running time	0~6500.0s(h)	0~6500.0s	0.0s(h)	○	0
FC.43	Simple PLC paragraph 12 acceleration and deceleration time	0~3	0~3	0	○	0
FC.44	Simple PLC Period 13 Runtime	0~6500.0s(h)	0~6500.0s	0.0s(h)	○	0
FC.45	Simple PLC paragraph 13 acceleration and deceleration time	0~3	0~3	0	○	0
FC.46	Simple PLC period 14 running time	0~6500.0s(h)	0~6500.0s	0.0s(h)	○	0
FC.47	Simple PLC paragraph 14 acceleration and deceleration time	0~3	0~3	0	○	0
FC.48	Easy PLC Period 15 Runtime	0~6500.0s(h)	0~6500.0s	0.0s(h)	○	0
FC.49	Simple PLC paragraph 15 acceleration and deceleration time	0~3	0~3	0	○	0
FC.50	Easy PLC running time unit	0: s (sec), 1: h (hour)	0~1	0	○	0
FC.51	Multi-segment speed 0 is given mode	0: Function code: FC.00 Given 1: VCI 2: CCI 3: Panel potentiometer 4: Pulse setting X5 5: PID 6: Given the preset frequency (F0.08), UP / DOWN can be modified	0~6	0	○	0
FD Group Communication Parameter						
F D .00	Communication Porter rate	Individual bit: MODBUS 0: 300BPS 1: 600BPS 2: 1200BPS 3: 2400BPS 4: 4800BPS 5: 9600BPS 6: 19200BPS 7: 38400BPS 8: 57600BPS 9: 115200BPS Ten places: Profibus-DP 0: 115200BPs 1: 208300BPs 2: 256000BPs 3: 512000Bps	0~9	6005	○	0

FC	name	Parameters are detailed	Set the scope	default value	change	target
		100 Positions: Keep Thousand bits: CANlink Porter rate 0: 20 1: 50 2: 100 3: 125 4: 250 5: 500 6: 1M				
F D .01	The MODBUS data format	0: No calibration (8-N-2) 1: Dual (8-E-1) 2: Strange check (8-O-1) 3: No calibration (8-N-1) (MODBUS valid)	0~3	0	○	0
F D .02	This machine address	0: Radio address 1~247 (MODBUS, Profibus-DP, CANlink are valid)	0~247	1	○	0
F D .03	The MODBUS response was delayed	0~20ms(MODBUS valid)	0~20	2	○	0
F D .04	Serial port communication timeout time	The 0.0s: Invalid, 0.1 ~ 60.0s (MODBUS, Profibus-DP, CANlink are valid)	0.00~60.00	0.00s	○	0
F D .05	MODBUS, Profibus-DP communication data format	Individual bit: MODBUS 0: Non-standard MODBUS-RTU protocol 1: Standard MODBUS-RTU protocol Ten places: Profibus-DP 0: PPO1 format 1: PPO2 format 2: The PPO3 format 3: PPO5 format	0~3	30	○	0
F D .06	Communication to read the current resolution	0: 0.01A 1: 0.1A	0~3	0	○	0
F D .08	Expansion card (Pfibus, CANopen) interrupt detection time	The 0.0s: Invalid 0.1~60.0s	0.0~60.0	0.0s	○	0
FE Group User-Defined Custom Function Code						
FE.00	User function code 0	F0.00~FP.xx	F0.00~FP.xx	U3.17	○	0
FE.01	User function code 1	A0.00~AX.xx	A0.00~AX.xx	U3.17	○	0

FC	name	Parameters are detailed	Set the scope	default value	change	target
FE.02	User function code 2	U0.00~U0.xx	U0.00~U0.xx	F0.00	○	0
FE.03	User function code 3	U3.00~U3.xx	U3.00~U3.xx	F0.00	○	0
FE.04	User function code 4			F0.00	○	0
FE.05	User function code 5			F0.00	○	0
FE.06	User function code 6			F0.00	○	0
FE.07	User function code 7			F0.00	○	0
FE.08	User function code 8			F0.00	○	0
FE.09	User function code 9			F0.00	○	0
FE.10	User Function Code 10			F0.00	○	0
FE.11	User Function Code 11			F0.00	○	0
FE.12	User Function Code 12			F0.00	○	0
FE.13	User Function Code 13			F0.00	○	0
FE.14	User Function Code 14			F0.00	○	0
FE.15	User Function Code 15			F0.00	○	0
FE.16	User Function Code 16			F0.00	○	0
FE.17	User Function Code 17			F0.00	○	0
FE.18	User Function Code 18			F0.00	○	0
FE.19	User Function Code 19			F0.00	○	0
FE.20	User function code 20			U 0.68	○	0
FE.21	User Function Code 21			U 0.69	○	0
FE.22	User Function Code 22			F0.00	○	0
FE.23	User Function Code 23			F0.00	○	0
FE.24	User Function Code 24			F0.00	○	0

FC	name	Parameters are detailed	Set the scope	default value	change	target
FE.25	User Function Code 25			F0.00	○	0
FE.26	User Function Code 26			F0.00	○	0
FE.27	User Function Code 27			F0.00	○	0
FE.28	User Function Code 28			F0.00	○	0
FE.29	User Function Code 29			F0.00	○	0
FP Group User Password						
FP.00	User password	0 ~ 65535	0 ~ 65535	0	○	0
FP.01	Parameter initialization	0: No operation 01: Restore the factory parameters, excluding the motor parameters 02: Clear the record information 04: Backup the user parameters 501: Restore the user parameters	0、01、02、01、501	0	◎	0
FP.02	Functional parameter group display selection	Individual bit: U group display selection 0: Do not show 1: Show Ten digits: Group A display selection 0: Do not show 1: Show	0 ~ 1	11	◎	0
FP.03	Personality parameter group display selection	Individual bit: User-customized parameter group display selection 0: Do not show 1: Show Ten digits: User change parameter group display selection 0: Do not show 1: Show	0 ~ 1	00	○	0
FP.04	The Function code modifies the attribute	0: Modifiable 1: Unmodifiable	0 ~ 1	0	○	0
A0 Group Torque Control Parameters						
A0.00	Speed / torque control mode selection	0: Speed control 1: Torque control	0 ~ 1	0	◎	0
A0.01	Torque setting source	0: Number setting 1 (A0.03)	0 ~ 7	0	◎	0

FC	name	Parameters are detailed	Set the scope	default value	change	target
	selection under the torque control mode	1: VCI 2: CCI 3: Panel potentiometer 4: High-speed pulse X5 5: Communication given 6: MIN(VCI,CCI) 7: MAX(VCI,CCI) (Full range of 1-7 options, corresponding to A0.03 number setting)				
A0.03	Torque number setting under the torque control mode	-200.0~200.0%	-200.0~200.0%	150.0%	○	0
A0.05	Torque controls the forward maximum frequency	0.00Hz ~F0.10 (Maximum frequency)	0.00Hz ~F0.10	50.00Hz	○	0
A0.06	Torque control for reverse maximum frequency	0.00Hz ~F0.10 (Maximum frequency)	0.00Hz ~F0.10	50.00Hz	○	0
A0.07	Torque acceleration time	0.00~650.00s	0.00~650.00	0.00s	○	0
A0.08	Torque deceleration time	0.00~650.00s	0.00~650.00	0.00s	○	0
A1 Group Virtual DI /Virtual DO						
A1.00	Virtual VX1 terminal function selection	0~59	0~59	0	◎	0
A1.01	Virtual VX2 terminal feature selection	0~59	0~59	0	◎	0
A1.02	Virtual VX3 terminal function selection	0~59	0~59	0	◎	0
A1.03	Virtual VX4 terminal function selection	0~59	0~59	0	◎	0
A1.04	Virtual VX5 terminal function selection	0~59	0~59	0	◎	0
A1.05	Virtual VX terminal valid state setting mode	0: The status of the virtual VDOx determines whether the VX is valid 1: Whether VX is set by function code A1-06 Individual bit: Virtual VX1 Ten digits: Virtual VX2 100 bits: virtual VX3 Thousand-bits: virtual VX4 Ten thousand bits: virtual VX5	0 ~ 1	00000	◎	0
A1.06	Virtual VX terminal status settings	0: invalid 1: valid Individual bit: Virtual VX1 Ten digits: Virtual VX2 100 bits: virtual VX3	0 ~ 1	00000	◎	0

FC	name	Parameters are detailed	Set the scope	default value	change	target
		Thousand-bits: virtual VX4 Ten thousand bits: virtual VX5				
A1.07	The VCI terminals serve as a functional choice at DI	0~59	0~59	0	☉	0
A1.08	CCI terminals as a functional choice at DI	0~59	0~59	0	☉	0
A1.09	Panel potentiometer as DI	0~59	0~59	0	☉	0
A1.10	The simulation quantity is used as the valid mode selection when DI	0: Effective at a high power level 1: Effective at the low level the unit:VCI decade:CCI Hundred bits: panel potentiometer	0 ~ 1	000	☉	0
A1.11	Virtual VDO1 output function selection	0: Internal short contact with the physical Xx terminal 1 ~ 40: See F5 Group physical DO output selection	0 ~ 40	0	○	0
A1.12	Virtual VDO2 output function selection	0: Internal short contact with the physical Xx terminal 1 ~ 40: See F5 Group physical DO output selection	0 ~ 40	0	○	0
A1.13	Virtual VDO3 output function selection	0: Internal short contact with the physical Xx terminal 1 ~ 40: See F5 Group physical DO output selection	0 ~ 40	0	○	0
A1.14	Virtual VDO4 output function selection	0: Internal short contact with the physical Xx terminal 1 ~ 40: See F5 Group physical DO output selection	0 ~ 40	0	○	0
A1.15	Virtual VDO5 output function selection	0: Internal short contact with the physical Xx terminal 1 ~ 40: See F5 Group physical DO output selection	0 ~ 40	0	○	0
A1.16	VDO1 Output delay ency	0.0~3600.0s	0.0~3600.0	0.0s	○	0
A1.17	VDO2 output delay time	0.0~3600.0s	0.0~3600.0	0.0s	○	0
A1.18	VDO3 Output Delency	0.0~3600.0s	0.0~3600.0	0.0s	○	0
A1.19	VDO4 Output Delency	0.0~3600.0s	0.0~3600.0	0.0s	○	0
A1.20	VDO5 Output delay ency	0.0~3600.0s	0.0~3600.0	0.0s	○	0
A1.21	VDO output terminal valid state selection	0: Positive logic 1: Anti-logic Individual bit: VDO1 Ten places: VDO2	0 ~ 1	00000	○	0

FC	name	Parameters are detailed	Set the scope	default value	change	target
		Hundred bits: VDO3 Thousand bits: VDO4 Ten thousand bits: VDO5				
A2 Group Motor 2 Parameters						
A2.00	Motor type selection	0: Ordinary Asynchronous motor 1: Inverency Asynchronous motor	0~1	0	☉	1
A2.01	The motor is rated power	0.1~1000.0kW	0.1~1000.0	Model determination	☉	1
A2.02	The motor is rated voltage	1~2000V	1~2000	Model determination	☉	1
A2.03	Rated current of motor	0.01~655.35A (frequency converter power: 55kW) 0.1~6553.5A (frequency converter power> 55kW)	0.01~6553.5	Model determination	☉	1
A2.04	Rated frequency of motor	0.01Hz ~F0.10 (Maximum frequency)	0.01Hz ~F0.10	Model determination	☉	1
A2.05	Motor rated speed	1~65535rpm	1~65535	Model determination	☉	1
A2.06	Aynchronous motor stator resistance	0.001~65.535 Ω (frequency converter power 55kW) 0.0001~6.5535 Ω (frequency converter power> 55kW)	0.0001~65.535	Model determination	☉	1
A2.07	Asochronous motor rotor resistance	0.001~65.535 Ω (frequency converter power 55kW) 0.0001~6.5535 Ω (frequency converter power> 55kW)	0.0001~65.535	Model determination	☉	1
A2.08	Leakresistance of asynchronous motor	0.01~655.35mH (frequency converter power: 55kW) 0.001~65.535mH (frequency converter power> 55kW)	0.001~655.35	Model determination	☉	1
A2.09	Aynchronous motor mutual resistance	0.1~6553.5mH (frequency converter power: 55kW) 0.01~655.35mH (frequency converter power> 55kW)	0.01~6553.5	Model determination	☉	1
A2.10	No load current of assynchronous motor	0.01~A2.03 (frequency converter power: 55kW) 0.1~A2.03 (, frequency converter power> 55kW)	0.01~A2.03	Model determination	☉	1
A2.27	Number of encoder lines	1~65535	1~65535	1024	☉	1
A2.28	Encoder type	0: ABZ, the incremental encoder 1: UVW, the incremental encoder 2: Rotary transformer 3: Sousine encoder 4: Provincial line mode UVW encoder	0 ~ 4	0	☉	1

FC	name	Parameters are detailed	Set the scope	default value	change	target
A2.29	Speed Feedback PG selection	0: Local PG 1: Extended PG 2: X5 terminal pulse input	0 ~ 2	0	⊙	1
A2.30	ABZ Incremental encoder AB phase sequence	0: Forward; 1: reverse	0~1	0	⊙	1
A2.31	Encoder installation angle	0.0° ~359.9°	0.0° ~359.9°	0.0°	⊙	1
A2.32	The UVW encoder UVW phase sequence	0: Forward; 1: reverse	0~1	0	⊙	1
A2.33	UVW bias angle encoder	0.0° ~359.9°	0.0° ~359.9°	0.0°	⊙	1
A2.34	Rotary transformer pole-logarithm	1~65535	1~65535	1	⊙	1
A2.36	Speed feedback PG disconnection detection time	0.0: No action; 0.1s ~10.0s	0.0 ~ 10.0	0.0s	⊙	1
A2.37	Tune selection	0: No operation 1: Aynchronous static tuning 1 2: Aynchronous dynamic tuning 3: Aynchronous static tuning 2	0 ~ 3	0	⊙	1
A2.38	Speed-loop proportional gain of 1	1~100	1~100	30	○	1
A2.39	The velocity loop integral time 1	0.01~10.00s	0.01~10.00	0.50s	○	1
A2.40	Switch frequency 1	0.00Hz~A2.43	0.00Hz~A2.43	5.00Hz	○	1
A2.41	Speed loop proportional gain 2	1~100	1~100	15	○	1
A2.42	The velocity loop integral time 2	0.01~10.00s	0.01~10.00	1.00s	○	1
A2.43	Switch frequency 2	A2.40~F0.10	A2.40~F0.10	10.00Hz	○	1
A2.44	Vector-controlled transfer gain	50%~200%	50%~200%	100%	○	1
A2.45	SVC torque-filtering constants	0.000s-0.015s	0.000s-0.015s	0.000s	○	1
A2.47	Torque upper limit source under speed control mode	0: A2.48 Setting 1: VCI 2: CCI 3: Panel potentiometer 4: X5 terminal pulse 5: Communication given 6: MIN(VCI,CCI) 7: MAX(VCI,CCI) Full range of option 1-7, corresponding to the A2.48 number setting	0 ~ 7	0	○	1

FC	name	Parameters are detailed	Set the scope	default value	change	target
A2.48	Torque upper limit number is set in the speed control mode	0.0%~ 200.0%	0.0%~ 200.0%	150%	○	1
A2.49	Torque upper limit instruction selection under speed control mode (power generation)	0: Function code F2-10 setting; 1: AI1; 2: AI2; 3: AI3; 4: PULSE pulse setting; 5: communication given; 6: MIN (AI1, AI2); 7: MAX (AI1, AI2); 8: Function code F2-12 setting Note: The full range of option 1-7 corresponds to F2-12		2000	○	
A2.50	Number setting of torque upper limit under speed control mode (power generation)	0.0%-200.0%	0.0%-200.0%	150.0%	○	1
A2.51	Excitation regulation proportional gain	0~20000	0~20000	2000	○	1
A2.52	Excitation adjustment integral gain	0~20000	0~20000	1300	○	1
A2.53	Torque adjustment proportional gain	0~20000	0~20000	2000	○	1
A2.54	Torque adjustment integral gain	0~20000	0~20000	1300	○	1
A2.55	Speed loop integral property	Individual bit: integral separation 0: invalid 1: valid	0~1	0	○	1
A2.59	Maximum torque coefficient in the weak magnetic region	50~200%	50~200%	100		1
A2.60	Generation power limit enables	0: invalid 1: valid	0~1	0		1
A2.61	Power cap	Power cap	0.0 ~ 200.0%	According to the model		1
A2.62	2. Motor control mode	0: No speed sensor for vector control (SVC) 1: Speed sensor vector control (FVC) 2: V / F control	0~2	0		1
A2.63	Second motor acceleration and deceleration time selection	0: Same as for motor 1 1: Increase and deceleration time 1 2: Increase and deceleration time 2 3: Increase and deceleration time 3 4: Increase and deceleration time 4	0~4	0		1
A2.64	2. Motor torque lift	0.0%: Automatic torque is increased by 0.1% ~30.0%	0.0%~ 30.0%	According to the model		1
A2.65	—	—				1
A2.66	Second motor oscillation suppression gain	0~100	0~100	Model determination	○	1

FC	name	Parameters are detailed	Set the scope	default value	change	target
A5 Group Control Optimization Parameters						
A5.00	DPWM switch limit frequency	5.00Hz~F0.10 (Maximum frequency)	5.00Hz~F0.10 (Maximum frequency)	8.0Hz	○	0
A5.01	PWM modulation mode	0: Asynchronous modulation 1: Synchronous modulation	0 ~ 1	0	○	0
A5.02	Dead zone compensation mode selection	0: No compensation 1: Compensation model: 1	0 ~ 1	1	○	0
A5.03	Random PWM depth	0: Invalid random PWM 1~10: PWM carrier frequency random depth	0 ~ 10	0	○	0
A5.04	Fast flow limiting enabling	0: Don't make it 1: Enable	0 ~ 1	1	○	0
A5.05	Maximum output voltage coefficient	100 ~ 110%	100 ~ 110%	105%	○	0
A5.06	Underpressure point setting	Three-phase: 380-480V model: 140.0V-380.0V Three-phase: 200-240V model: 140.0V-380.0V	140.0V-380.0V	350V	○	0
A5.07	SVC optimization mode selection	1: Optimization mode 1 2: Optimization mode 2	1 ~ 2	2	○	0
A5.08	Time adjustment of dead zone	100%~200%	100%~200%	150%	◎	0
A5.09	Overpressure point setting	Three-phase: 380-480V model: 200.0V-820.0V Three-phase: 200-240V model: 200.0V-400.0V	200.0V-820.0V	Model determination	◎	0
A6 Group AI Curve Setting						
A6.00	Simulation quantity curve 4 minimum input	-10.00V~A6.02	-10.00V~A6.02	0.00V	○	0
A6.01	The minimum input of the analog quantity curve 4 corresponds to the setting	-100%~100%	-100%~100%	0.0%	○	0
A6.02	Simulation volume curve 4 inflection point 1 input	A6.00~ A6.04	A6.00~ A6.04	3.00V	○	0
A6.03	Simulation curve 4 inflection point 1 input corresponding setting	-100%~100%	-100%~100%	30.0%	○	0
A6.04	Simulation volume curve 4 inflection point 2 input	A6.02~ A6.06	A6.02~ A6.06	6.00V	○	0
A6.05	Simulation curve 4 inflection point 2 input corresponding setting	-100%~100%	-100%~100%	60.0%	○	0
A6.06	Simog curve 4 maximum input	A6.06~10.00V	A6.06~10.00V	10.00V	○	0

FC	name	Parameters are detailed	Set the scope	default value	change	target
A6.07	The maximum input corresponds to the setting	-100%~100%	100.0%	100.0%	○	0
A6.08	Analog quantity curve, 5 minimum input	-10.00V~A6.10	-10.00V~A6.10	-10.00V	○	0
A6.09	The minimum input of the analog quantity curve 5 corresponds to the setting	-100%~100%	-100%~100%	100.0%	○	0
A6.10	Simulation volume curve 5 inflection point 1 input	A6.08~A6.12	A6.08~A6.12	-3.00V	○	0
A6.11	Simulation curve 5 inflection point 1 input corresponding setting	-100%~100%	-100%~100%	-30.0%	○	0
A6.12	Simulation volume curve 5 inflection point 2 input	A6.10~A6.14	A6.10~A6.14	3.00V	○	0
A6.13	Simulation curve 5 inflection point 2 input corresponding setting	-100%~100%	-100%~100%	-30.0%	○	0
A6.14	Simog curve 5 maximum input	A6.12~10.00V	A6.12~10.00V	10.00V	○	0
A6.15	The maximum input corresponds to the setting	-100%~100%	-100%~100%	100.0%	○	0
A6.24	The VCI sets the jump point	-100%~100%	-100%~100%	0.0%	○	0
A6.25	The VCI sets the jump amplitude	0.0%~100.0%	0.0%~100.0%	0.5%	○	0
A6.26	The CCI sets the jump point	-100%~100%	-100%~100%	0.0%	○	0
A6.27	The CCI sets the jump amplitude	0.0%~100.0%	0.0%~100.0%	0.5%	○	0
A6.28	Panel potentiometer sets the jump point	-100%~100%	-100%~100%	0.0%	○	0
A6.29	Panel potentiometer sets the jump range	0.0%~100.0%	0.0%~100.0%	0.5%	○	0
A6 Group User Programmable Function						
A7.00	User-programmable feature selection	0: invalid 1: valid	0 ~ 1	0	◎	0
A7.01	Control board output terminal control mode selection	0: The frequency converter is control 1: User-programmable control card control Individual bit: switch volume output Ten-place: Relay (TA-TB-TC 100 Position: DO1 Thousand bits: pulse output Ten thousand positions: AO1	0 ~ 1	0	◎	0

FC	name	Parameters are detailed	Set the scope	default value	change	target
A7.02	Programmable card extends the AIAO terminal function configuration	0: Voltage input, AO2 voltage output 1: Voltage input, AO2 current output 2: Current input, AO2 voltage output	0 ~ 7	0	⊙	1
A7.03	Pulse output	0.0%~100.0%	0.0%~100.0%	0.0%	○	0
A7.04	AO1 output	0.0%~100.0%	0.0%~100.0%	0.0%	○	0
A7.05	Switch output	Binary setting 0: disable; 1: enable Ones place: switch output Tens place: Relay 1 Hundreds: DO	0 ~ 1	1	○	0
A7.06	Programmable card frequency given	-100%~100%	0.0%~100.0%	0.0%	○	1
A7.07	Programmable card torque given	-200%~200%	-200%~200%	0.0%	○	1
A7.08	Programmable card command given	0: no command 1: Forward rotation command 2: Reverse command 3: Forward jog 4: Reverse jog 5: Free stop 6: Decelerate to stop 7: Fault reset	0 ~ 7	0	○	1
A7.09	Programmable card given fault	0: no fault 80~89: fault code	0、80~89	0	○	1
A8 Group Point-to-point communication						
A8.00	Valid options for peer-to-peer communication	0: invalid 1: Valid	0 ~ 1	0	○	1
A8.01	Master-slave selection	0: Master 1: Slave	0 ~ 1	0	○	1
A8.02	master-slave information interaction	Units: 0: do not follow the host command 1: Follow host command Ten: 0: No fault information is sent 1: Send fault information	0 ~ 1	011	○	1

FC	name	Parameters are detailed	Set the scope	default value	change	target
		hundreds: 0: No alarm when the slave is dropped 1: Slave drop alarm				
A8.03	The slave accepts the data action selection	0: The torque is given 1: Frequency given	0 ~ 1	0	○	1
A8.04	Zero bias (torque)	-100.00% ~ 100.00%	-100.00%~100.00%	0.00%	◎	1
A8.05	Receive data gain (torque)	-10~ 100.00 .0	-10~ 100.00 .0	1.00	◎	1
A8.06	Point-to-peer communication interruption detection time	0.0~10.0s	0.0~10.0	1.0s	○	1
A8.07	Point-to-peer communication host data transmission period	0.001~10.000s	0.001~10.000	0.001s	○	1
A8.08	Zero bias of received data (frequency)	-100.00% ~ 100.00%	-100.00% ~ 100.00%	0.00%	◎	1
A8.09	Receive data gain (frequency)	-10.00~100.00	-10.00~100.00	1.00	◎	1
A8.11	window	0.20 ~10.00Hz	0.20 ~10.00	0.50Hz	◎	1
Ac Group AI/AO Correction						
AC.00	VCI measured voltage 1	0.500~4.000V	0.500~4.000V	Factory correction	○	0
AC.01	The VCI shows the voltage of 1	0.500~4.000V	0.500~4.000V	Factory correction	○	0
AC.02	VCI-measured voltage 2	6.000~9.999V	6.000~9.999V	Factory correction	○	0
AC.03	The VCI shows the voltage of 2	6.000~9.999V	6.000~9.999V	Factory correction	○	0
AC.04	CCI measured voltage 1	0.500~4.000V	0.500~4.000V	Factory correction	○	0
AC.05	The CCI shows the voltage of 1	0.500~4.000V	0.500~4.000V	Factory correction	○	0

FC	name	Parameters are detailed	Set the scope	default value	change	target
AC.06	CCI-measured voltage 2	6.000~9.999V	6.000~9.999V	Factory correction	○	0
AC.07	The CCI shows the voltage of 2	6.000~9.999V	6.000~9.999V	Factory correction	○	0
AC.08	Measured voltage of the panel potentiometer: 1	-9.999~10.000V	-9.999~10.000V	Factory correction	○	0
AC.09	Panel potentiometer displays voltage 1	-9.999~10.000V	-9.999~10.000V	Factory correction	○	0
AC.10	Measured voltage of the panel potentiometer: 2	-9.999~10.000V	-9.999~10.000V	Factory correction	○	0
AC.11	Panel potentiometer displays voltage 2	-9.999~10.000V	-9.999~10.000V	Factory correction	○	0
AC.12	A01 Target Voltage 1	0.500~4.000V	0.500~4.000V	Factory correction	○	0
AC.13	A01 Measured voltage 1	0.500~4.000V	0.500~4.000V	Factory correction	○	0
AC.14	A01 Target Voltage 2	6.000~9.999V	6.000~9.999V	Factory correction	○	0
AC.15	A01. Measured voltage 2	6.000~9.999V	6.000~9.999V	Factory correction	○	0
AC.16	A02 Target Voltage 1	0.500~4.000V	0.500~4.000V	Factory correction	○	0
AC.17	A02 Measured voltage 1	0.500~4.000V	0.500~4.000V	Factory correction	○	0
AC.18	A02 Target Voltage 2	6.000~9.999V	6.000~9.999V	Factory correction	○	0
AC.19	A02 Measured voltage 2	6.000~9.999V	6.000~9.999V	Factory correction	○	0

pour:

Column 1 "Function Code": the number of functional parameter group and parameters;

Column 2: Name: the full name of the functional parameter;

Column 3 "Parameter Detailed Description": is a detailed description of this functional parameter;

Column 4 "Set range": displays the valid set value range of the functional parameters on the keyboard LCD LCD display;

Column 5 "Default Value": the original factory set value for the functional parameters;

Column 6 Changes: Change properties for a functional parameter (i. e. whether to change and change conditions are allowed), as follows:

"o": indicates that the setting value of this parameter can be changed when the frequency converter is in the shutdown and running state;

"⊙": indicates that the set value of this parameter cannot be changed when the frequency converter is in the running state;

"●": The value of the parameter is the actual detected record value and cannot be changed;

"*": It means that the parameter is a "manufacturer parameter", which is only set by the manufacturer, and prevents users from operating;

Column 7 "object": whether the corresponding 650 series and 650L series have this function parameter, as described below:

"o": indicates that 650 series and 650L series have this function parameter;

"1": This function parameter is unique to the 650 series, while 650L does not have this function;

"2": This function parameter is unique to the 650L series, while the 650 does not have this function.

FC	name	Minimum unit	postal address
U0.00	running frequency (Hz)	0.01Hz	7000H
U0.01	Set Frequency (Hz)	0.01Hz	7001H
U0.02	busbar voltage (V)	0.1V	7002H
U0.03	output voltage (V)	1V	7003H
U0.04	output (A)	0.01A	7004H
U0.05	output power (kW)	0.1kW	7005H
U0.06	Output torque (%) Percent output value of the motor rated torque	0.1%	7006H
U0.07	DI input mode	1	7007H
U0.08	DO output state	1	7008H
U0.09	VCI voltage (V)	0.01V	7009H
U0.10	CCI voltage (V) / current (mA)	0.01V/0.01mA	700AH
U0.11	Panel potentiometer voltage (V)	0.01V	700BH
U0.12	count value	1	700CH
U0.13	Length value	1	700DH
U0.14	Load speed is shown	1	700EH
U0.15	PID setting	1	700FH
U0.16	PID feedback	1	7010H
U0.17	PLC stage	1	7011H

FC	name	Minimum unit	postal address
U0.18	X5 terminal input pulse frequency (Hz)	0.01kHz	7012H
U0.19	Feedback speed (Hz)	0.01Hz	7013H
U0.20	The remaining running time	0.1Min	7014H
U0.21	VCI correction front voltage	0.001V	7015H
U0.22	CCI for correction of the front voltage / current	0.001V/0.01mA	7016H
U0.23	Panel potentiometer correction front voltage	0.001V	7017H
U0.24	linear velocity	1m/Min	7018H
U0.25	Current power time	1Min	7019H
U0.26	Current run time	0.1Min	701AH
U0.27	The X5 terminal input pulse frequency	1Hz	701BH
U0.28	Communication set value	0.01%	701CH
U0.29	Encoder feedback speed	0.01Hz	701DH
U0.30	The primary frequency is shown	0.01Hz	701EH
U0.31	Auxiliary frequency display	0.01Hz	701FH
U0.32	View any memory address values	1	7020H
U0.34	Motor temperature value	1°C	7022H
U0.35	Target torque	0.1%	7023H
U0.36	The rotation position	1	7024H
U0.37	Power factor Angle	0.1°	7025H
U0.38	ABZ position	1	7026H
U0.39	The VF separates the target voltage	1V	7027H
U0.40	VF to separate the output voltage	1V	7028H
U0.41	The X-terminal input status is visually displayed	1	7029H
U0.42	The DO output status is visually displayed	1	702AH
U0.43	The X terminal functional status displays visually for 1	1	702BH
U0.44	The X terminal functional status displays visually for the 2	1	702CH
U0.45	fault message	1	702DH
U0.58	Z event counter	1	703AH
U0.59	Set the frequency of (%)	0.01%	703BH
U0.60	running frequency	0.01%	703CH
U0.61	frequency converter operating status	1	703DH
U0.62	Current fault coding	1	703EH
U0.63	Point-to-peer communication transmission value	0.01%	703FH
U0.64	Number of stations	1	7040H

FC	name	Minimum unit	postal address
U0.65	Cycle upper limit	0.01%	7041H
U0.66	Communication extension card model	100:CANOpen 200:Profibus-DP 300:CANLink	7042H
U0.67	Communication extension card version number	indication range	-
U0.68	DP card frequency converter status	The bit0 is running status The bit1 running direction The bit2-is the frequency converter faulty The bit3-target frequency arrival Keep the bit4~bit7 The bit8~bit15 fault code	7043H
U0.69	Speed of the transfer DP card / 0.01hz	0.00~ F0.10 (Maximum frequency)	7044H
U0.70	Transfer the DP speed / RMP	0~65535	7045H
U0.71	Special current display for the communication card	indication range	-
U0.72	Communication card error status	indication range	-
U0.73	Motor serial number	0: Motor 1 1: Motor 2	7046H
U0.74	Motor actual output torque	-300-300%	7047H

Chapter-5 Troubleshooting

5.1 Fault information and troubleshooting method

Fault code	fault type	Possible causes of the failure	the way to deal with a situation
Err01	Inverter unit protection	<ol style="list-style-type: none"> 1. Short circuit of the inverter output loop 2. The wiring of the motor and the inverter is too long 3. Overheating of modules 4. The internal wiring of the inverter is loose 5. The main control board is abnormal 6. The drive board is abnormal 7. Inverse module is abnormal 	<ol style="list-style-type: none"> 1. Troubleshoot the peripheral faults 2. Install the reactor or the output filter 3. Check whether the air duct is blocked, whether the fan works normally, and eliminate the existing problems 4. Plug in all the connecting cables 5. Seek technical support 6. Seek technical support 7. Seek technical support
Err02	Accelerate over current	<ol style="list-style-type: none"> 1. There is ground or short circuit 2. The control mode is vector and no parameter tuning 3. Acceleration time is too short 4. Manual torque lifting or V / F curve is not appropriate 5. Low voltage 6. Start the rotating motor 7. Sudden loading during acceleration 8. The inverter type selection is too small 	<ol style="list-style-type: none"> 1. Troubleshoot the peripheral faults 2. Tune the motor parameters 3. Increase the acceleration time 4. Adjust the manual lifting torque or V / F curve 5. Adjust the voltage to the normal range 6. Select the speed tracking start or wait the motor to stop before starting 7. Cancel the sudden load 8. Choose the frequency converter with a larger power level
Err03	Slow down over current	<ol style="list-style-type: none"> 1. There is ground or short circuit 2. The control mode is vector and no parameter tuning 3. The deceleration time is too short 4. Low voltage 5. Add the load suddenly during the deceleration process 6. No brake unit and brake resistance are installed 	<ol style="list-style-type: none"> 1. Troubleshoot the peripheral faults 2. Tune the motor parameters 3. Increase the deceleration time 4. Adjust the voltage to the normal range 5. Cancel the sudden load 6. Install the brake unit and the resistance
Err04	Constant speed over current	<ol style="list-style-type: none"> 1. There is ground or short circuit 2. The control mode is vector and no parameter tuning 3. Low voltage 4. Whether there is a sudden adding load in the operation 5. The selection of the inverter is too small 	<ol style="list-style-type: none"> 1. Troubleshoot the peripheral faults 2. Tune the motor parameters 3. Adjust the voltage to the normal range 4. Cancel the sudden adding load 5. Choose the frequency converter with a larger power level
Err05	Accelerated overvoltage	<ol style="list-style-type: none"> 1. High input voltage 2. There is an external force dragging the motor during the acceleration process 3. The acceleration time is too short 4. No brake unit and brake resistance are installed 	<ol style="list-style-type: none"> 1. Adjust the voltage to the normal range 2. Cancel additional power or install brake resistance 3. Increase the acceleration time 4. Install the brake unit and the resistance

Fault code	fault type	Possible causes of the failure	the way to deal with a situation
Err06	Slow down over voltage	<ol style="list-style-type: none"> 1. High input voltage 2. There is an external force dragging the motor in the deceleration process 3. The deceleration time is too short 4. No brake unit and brake resistance are installed 	<ol style="list-style-type: none"> 1. Adjust the voltage to the normal range 2. Cancel additional power or install brake resistance 3. Increase the deceleration time 4. Install the brake unit and the resistance
Err07	Constant speed overvoltage	<ol style="list-style-type: none"> 1. High input voltage 2. There is external forces dragging the motor during operation 	<ol style="list-style-type: none"> 1. Adjust the voltage to the normal range 2. Cancel additional power or install brake resistance
Err08	Control power failure	The input voltage is not within the range specified in the specification	Adjust the voltage to the range required by the specification
Err09	Underpressure failure	<ol style="list-style-type: none"> 1. Instantaneous power failure 2. The input voltage of the inverter is not within the range required by the specification 3. The bus voltage is abnormal 4. The rectifier bridge and the buffer resistance are abnormal 5. The drive board is abnormal 6. The control board is abnormal 	<ol style="list-style-type: none"> 1. Resignation failure 2. Adjust the voltage to the normal range 3. Seek technical support 4. Seek technical support 5. Seek technical support 6. Seek technical support
Err10	Frequency converter overload	<ol style="list-style-type: none"> 1. Whether the load is too large or motor blockage 2. The inverter type selection is too small 	<ol style="list-style-type: none"> 1. Reduce the load and check the motor and mechanical conditions 2. Choose the frequency converter with a larger power level
Err11	Motor overload	<ol style="list-style-type: none"> 1. Whether the motor protection parameter F9-01 is appropriate 2. Whether the load is too large or the motor blocked 3. The selection of the inverter is too small 	<ol style="list-style-type: none"> 1. Set this parameter correctly 2. Reduce the load and check the motor and mechanical conditions 3. Choose the frequency converter with a larger power level
Err12	Input the missing phase	<ol style="list-style-type: none"> 1. Three-phase input power supply is abnormal 2. The drive board is abnormal 3. Abnormal lightning protection plate 4. The main control board is abnormal 	<ol style="list-style-type: none"> 1. Check and eliminate the problems existing in the peripheral lines 2. Seek technical support 3. Seek technical support 4. Seek technical support
Err13	Output lack of phase	<ol style="list-style-type: none"> 1. The lead from the frequency converter to the motor is abnormal 2. The three-phase output of the inverter is unbalanced during the motor operation 3. The drive board is abnormal 4. Abnormal modules 	<ol style="list-style-type: none"> 1. Troubleshoot the peripheral faults 2. Check whether the three-phase winding of the motor is normal and eliminate the fault 3. Seek technical support 4. Seek technical support
Err14	The module overheating	<ol style="list-style-type: none"> 1. The ambient temperature is too high 2. The air duct is blocked 3. Fan damage 4. The module thermistor is damaged 5. The inverter module is damaged 	<ol style="list-style-type: none"> 1. Reduce the ambient temperature 2. Clean the air duct 3. Change the fan 4. Replace the thermistor 5. Replace the inverter module

Fault code	fault type	Possible causes of the failure	the way to deal with a situation
Err15	External equipment failure	<ol style="list-style-type: none"> 1. Input the external fault signal through the multifunctional terminal X terminal 2. Enter the external fault signal through the virtual IO function 	<ol style="list-style-type: none"> 1. Resignation operation 2. Reset operation
Err16	Communication failure	<ol style="list-style-type: none"> 1. The upper position computer does not work normally 2. The communication line is abnormal 3. The communication extension card F0-28 is not set correctly 4. Communication parameter FD group is not set correctly 	<ol style="list-style-type: none"> 1. Check the wiring of the upper position machine 2. Check the communication connection cable 3. Set the communication extension card type correctly 4. Set the communication parameters correctly
Err17	Contactor failure	<ol style="list-style-type: none"> 1. The drive plate and the power supply are abnormal 2. The contactor is abnormal 	<ol style="list-style-type: none"> 1. Replace the drive board or the power supply board 2. Replace the contactor
Err18	Current detection failure	<ol style="list-style-type: none"> 1. Check the Hall device abnormality 2. The drive board is abnormal 	<ol style="list-style-type: none"> 1. Replace the Hall devices 2. Replace the drive plate
Err19	Motor tuning fault	<ol style="list-style-type: none"> 1. Motor parameters are not set according to the nameplate 2. The parameter tuning process is timed out 	<ol style="list-style-type: none"> 1. Set the motor parameters correctly according to the nameplate 2. Check the inverter to the motor lead
Err20	Code disk failure	<ol style="list-style-type: none"> 1. The encoder model does not match 2. Encoder connection error 3. Cocoder is damaged 4. Exception of the PG card 	<ol style="list-style-type: none"> 1. Set the encoder type correctly according to the actual conditions 2. Troubleshoot the line fault 3. Replace the encoder 4. Replace the PG card
Err21	EEPROM read and write fault	The EEPROM chip is damaged	Replace the main control board
Err22	frequency converter hardware failure	<ol style="list-style-type: none"> 1. Overpressure exists 2. Overflow 	<ol style="list-style-type: none"> 1. Handle the overvoltage fault 2. Handle the overcurrent fault
Err23	Short circuit to ground fault	Motor short circuit to ground	Replace the cable or the motor
Err26	Cumulative runtime reaches the fault	The cumulative running time reaches the set point	Use the parameter initialization function to clear the record information
Err27	User-defined custom fault 1	<ol style="list-style-type: none"> 1. Enter the user through the multi-function terminal X terminal Custom signal for fault 1 <ol style="list-style-type: none"> 2. Enter user from through the virtual IO feature 3. Defines the signal for the fault-1 	<ol style="list-style-type: none"> 1. Resignation operation 2. Reset operation
Err28	User-custom fault 2	<ol style="list-style-type: none"> 1. Enter the user through the multi-function terminal X terminal Custom signal for fault 2 <ol style="list-style-type: none"> 2. Enter the user for customization through the virtual IO function 3. Signal for fault 2 	<ol style="list-style-type: none"> 1. Resignation operation 2. Reset operation

Fault code	fault type	Possible causes of the failure	the way to deal with a situation
Err29	The cumulative power-on time reaches the fault	The cumulative power-on time reaches the set value	Use the parameter initialization function to clear the record information
Err30	The load failure	The operating current of the frequency converter is less than F9.64	Verify whether the load is detached or F9.64 and F9.65 parameter settings Whether it conforms to the actual operating conditions
Err31	Runtime PID feedback lost fault	The PID feedback is less than the FA.26 Set the value	Check the PID feedback signal or set up the FA.26 For a suitable value
Err 40	Wave-by-wave flow limit failure	1. Whether the load is too large or motor blockage 2. The inverter type selection is too small	1. Reduce the load and check the motor and mechanical conditions 2. Choose the frequency converter with a larger power level
Err 41	Switch the motor fault during operation	Change by terminal during frequency converter operation Current motor selection	After the inverter is stopped, the motor is switched over
Err 42	Speed deviation is excessive fault	1、 Encoder parameters are not set correctly (At F0.01=1 time) 2. Motor plugging 3. Excessive speed deviation detection parameter F9.69, F9.70 Unsetup 4、 Frequter output UVW to motor The wiring is not normal	1. Set the encoder parameters correctly 2. Check whether the machinery is abnormal, whether the motor is parameter adjusted, Is the torque setpoint, of F2.10, small 2、 Detection parameters F9.69 and F9.70 are set unreasonable 4. Check whether the wiring between the frequency converter and the motor is disconnected
Err 43	Motor overspeed fault	1. Encoder parameters are not set correctly 2. No parameter tuning was performed 3. Motor overspeed detection parameter F9.67, F9.68 Unreasonable setting	1. Set the encoder parameters correctly 2. Tune the motor parameters 3. Set the test parameters reasonably according to the actual situation
Err 45	Motor overtemperature failure	1、 Flexible temperature sensor wiring 2、 The motor temperature is too high	1. Check the temperature sensor wiring and remove the fault 2. Reduce the load frequency or take other heat dissipation measures for the motor Radiation treatment
Err 51	Initial location error	The motor parameters are too different from the actual ones	Re-confirm that the motor parameters are correct, and focus on the rating Is the current set too small
Err 60	Brake pipe protection fault	The brake resistance is short-circuit or the brake module is abnormal	Check the brake resistance or seek technical support

5.2 Common faults and their handling methods

The following faults may be encountered during the use of the frequency converter, please refer to the following methods for simple fault analysis:

No power display on the ●:

- ◆ uses a multimeter to check whether the inverter input power supply is consistent with the inverter rated voltage. Please check and exclude the problem.

The ◆ checks whether the three-phase rectifier bridge is intact. If the rectified bridge has exploded, please seek service.

- ◆ Check that the CHARGE lamp is on. If this light is not on, please seek a service.

Power supply air switch jumps off after ● power-up:

- ◆ Check for ground or short circuit between the input power supply to eliminate any problems.

- ◆ checks if the rectifier bridge has been broken, and if damaged, seek service.

The motor does not rotate after the ● frequency converter runs:

The ◆ checks for a balanced three-phase output between U, V, and W. If so, check if the motor is damaged or blocked. If this problem is free, please verify that the motor parameters are set correctly.

- ◆ can have output but three-phase imbalance, please seek a service.

If the ◆ has no output voltage, please seek a service.

● power converter is normal, the power supply air switch jumps off after operation:

- ◆ Check for short circuits between the output modules. If so, please seek for services.

- ◆ Check for a short circuit or ground between the motor leads. If so, please exclude the case.

- ◆ If the trip is seen occasionally, and the distance between the motor and the frequency converter is relatively far, then consider adding the output AC reactor.

Chapter-6 Maintenance and Maintenance



warn

- Maintenance personnel must follow the specified methods of maintenance and maintenance.
- Maintenance personnel shall be conducted by professional and qualified personnel.
- Before maintenance, the power of frequency converter must be cut off and maintenance can be carried out after 10 minutes.
- Do not directly touch the components on the PCB board, otherwise it is easy to electrostatic damage to the frequency converter.
- After maintenance, you must confirm that all screws are tightened.

6.1 Daily maintenance

In order to prevent the failure of the converter, ensure the normal operation of the equipment and extend the service life of the converter, daily maintenance of the contents of daily maintenance is as follows:

inspection item	content
Temperature / humidity	Confirm that the ambient temperature is 0℃ ~40℃ and the humidity is 20~90%
Oil mist and dust	Ensure that there is no oil mist and dust and no condensate in the frequency converter
frequency transformer	Check the frequency converter for any abnormal heating and abnormal vibration
electric fan	Verify that the fan is running normally, no debris is stuck, etc
Enter the power supply	Verify that the voltage and frequency of the input power supply are within the allowable range
any power-generating or power-driven machine	Check the motor for abnormal vibration, heating, abnormal noise and missing problems

6.2 Periodic maintenance

In order to prevent the inverter from failure and ensure its long-term high-performance and stable operation, the user must check the inverter regularly (within half a year), with the inspection contents expressed as follows:

inspection item	scope of examination	The exclusion method
Screw for the external terminals	Whether the screw is loose	screw home
PCB board	Dust, stolen goods	Clean up the debris completely with dry compressed air
electric fan	Whether the abnormal noise and vibration and cumulative time exceed 20,000 hours	1、 Remove debris 2、 Change the fan
electrolytic capacitor	Whether color change, whether peculiar smell	Replace the electrolytic capacitance
radiator	Dust, dirt	Clean up the debris completely with dry compressed air
Power components	Dust, dirt	Clean up the debris completely with dry compressed air

6.3 Replacement of vulnerable parts of frequency converter

- ◆ Fan: ◆ capacitor after more than 20,000 hours: after 30,000-40,000 hours

6.4 Warranty of the frequency converter

The company provides a 12-month warranty service for this series of frequency converter.

Chapter-7 Communication Agreement

7.1 Definition of the communication data address

Vector universal inverter supports four communication protocols: Modbus-RTU, CANopen, CANlink and Profibus-DP. User programmable card and point-to-point communication are derived from CANlink protocol. Through these communication protocols, the upper computer can control, monitor and modify the functional parameters of the inverter. Communication data can be divided into functional code data and non-functional code data, which includes running commands, running status, running parameters, alarm information, etc.

7.11 frequency converter function code data

Function code data is the important setting parameters of the frequency converter, as follows:

frequency transformer	Group F (readable and write)	F0、F1、F2、F3、F4、F5、F6、F7、F8、F9、FA、FB、FC、FD、FE、FF
	Group A (readable and write)	A0、A1、A2、A3、A4、A5、A6、A7、A8、A9、AA、AB、AC、AD、AE、AF

The function code data mailing address is defined as follows:

1. When reading functional code data for communication

For the functional code data of F0~FF and A0~AF groups, the communication address of 16 higher directly is the functional group number, and 16 lower directly numbers the functional code in the functional group. Examples are as follows:

F0.16 functional parameter, whose communication address is F010H, where F0H represents the functional parameters of group F0, and 10H represents the hexadecimal data format of the function code with the serial number 16 in the functional group

AC.08 Functional parameters, whose communication address is AC08, where ACH represents the AC group functional parameters, and 08H represents the hexadecimal data format of the functional code in the serial number 8 in the functional group

2. When the function code data is written for the communication

For function code data of F0~FF group, its communication address is 16 years high, which is 00~0F or F0~FF according to whether EEPROM is written. 1 F 6 years low is directly the serial number of function code in the function group. Examples are as follows:

Write function parameter F0.16, whose mailing address is 0010H or F010H.

For the A0~AF group function code data, its communication address is 16 years high, distinguished is 40~4F or A0~AF according to whether it needs to write to the EEPROM, and 16 years low is directly the serial number of the function code in the function group. Examples are as follows:

Write the function parameter AC.08, The EEPROM writing address is 4C08H, and when the EEPROM writing address is AC08H.

7.11 Frequter nonfunctional code data

Non-functional code data of the frequency converter	Status Data (Read-only)	Monitoring parameters of group U, fault description of frequency converter, and operation form of frequency converter
	Control Parameters (write-only)	Control command, communication setting value, digital output terminal control, analog output AO1 control, analog output AO2 control, high-speed pulse (DO) output control, parameter initialization state

1. Status data

Status data is divided into U group monitoring parameters, frequency converter fault description, and frequency converter operating status

U Group parameter monitoring parameters

Group U monitoring data is described in chapters V and 6, with the address defined as follows:

U0~UF, whose communication address of 16 is 70~7F, and 16 is the serial number of monitoring parameters in the group, as follows:

U0.11, with a corresponding address of 700BH

Frequency fault description

When the communication reads the fault description of the frequency converter, the communication address is fixed to 8000H, and the upper computer can obtain it by reading the address data

Current frequency converter fault code, fault code description is defined in Chapter 5 F9.14 function code

frequency converter operating status

When the communication reads the operating state of the inverter, the communication address is fixed to 3000H, which the upper computer can obtain by reading the address data

Current operating status information of the frequency converter, as defined as follows:

frequency converter operating status communication address	Read the state word definition
3000H	1: Forward operation 2: reverse operation 3: shutdown

Control parameters are divided into control command, digital output terminal control, analog output AO1 control, analog output AO2 control, and high-speed pulse output control

control command

When F0.02 (command source) is selected as 2: communication control, the upper computer can control the start and stop of the frequency converter through the communication address. The control command is defined as follows:

Control command address	Command function
2000H	1: Forward operation, 2: reverse operation, 3: forward point operation
	4: Reverse point move 5: free shutdown 6: deceleration shutdown 7: fault complex

Communication set value

Communication Setvalue The frequency source, torque upper limit source, VF separation voltage source, PID given source and PID feedback source in the main user converter are the given data of communication to timing. Its mailing address is 1000H, and when the host computer sets the mailing address value, the data range is-10000~10000, corresponding to the relative given value of-100.00%~100.00%

Digital output terminal control

When the digital output terminal function is selected as 20: communication control, the upper computer computer can control the digital output terminal of the inverter through the communication address, as defined as follows:

The digital output terminal controls the communication address	Command content
2001H	BIT0: DO1 output control BIT1: DO2 output control BIT2: RELAY1 output control BIT3: RELAY2 Output Control BIT4: DO output control BIT5:VDO1 BIT6:VDO2 BIT7:VDO3 BIT8:VDO4 BIT9:VDO5

Analog volume output AO1, AO2, high-speed pulse output DO control

When the analog volume output AO1 and AO2, and the high speed pulse output DO output function is selected as 12: In the communication setting, the upper computer computer can control the analog volume and high speed pulse output of the inverter through the communication address, which is defined as follows:

Output control communication address		Command content
AO1	2002H	0 ~ 7FFF indicates 0% ~ 100%
AO2	2003H	
pulse output	2004H	

Parameter initialization

This function is required when the parameter initialization of the inverter is required by the upper position computer.

if FP. If the 2000 (user password) is not 0, the password needs to be verified through communication first. After the verification passes, the upper computer will initialize the parameters within 30 seconds.

The communication address for the user password verification is 1F00H. If the correct user password is directly written to the address, the password verification can be completed

The address of communication is 1F01H and its data content is defined as follows:

The parameter initializes the address address	Command function	
1F01H	1: Restore the factory parameters	2: Clear record information
	4: Restore the user backup parameters	501: Backup the user's current parameters

7.2 Modbus communication protocol

Vector universal inverter provides RS485 communication interface and supports Modbus-RTU slave communication protocol. Users can realize centralized control through the computer or PLC, set the frequency converter operation command, modify or read the function code parameters, and read the working status and fault information of the frequency converter.

7.2.1. Content of the Agreement

The serial communication protocol defines the information content and usage format transmitted in the serial communication. Including: the host polling (or broadcast) format; the host coding method, including: the function code of the required action, transmission data and error verification. The response of the slave also adopts the same structure, including: action confirmation, return data and error verification. If the slave has an error when receiving the information, or it cannot complete the action required by the host, it organizes a failure information and gives feedback to the host as a response.

7.2.1.1 Application mode

The inverter is connected to the "single-master and multi-slave" PC / PLC control network with RS485 bus, as a communication slave.

7.2.1.2 Bus structure

(1) Hardware interface

RS485 extension Card 650-TX1 hardware on the converter.

(2) Topology structure

Single-host multi-slave system. Each communication device in the network has a unique station address, in which one device as the communication host (often flat PC upper computer, PLC, HMI, etc.), actively initiate communication, read or write parameters on the slave, other devices in the communication slave, in response to the host host inquiry or communication operations. Only one device can send the data while the other device is in the receiving state.

The slave address is set up from 1 to 247,0 as the broadcast communication address. The slave address in the network must be unique.

(3) Communication transmission mode

Asynchronous serial, semi-duplex transmission mode. During serial asynchronous communication, the data is sent once at a time. In the MODBUS-RTU protocol, when the idle time without data on the communication data line is greater than the 3.5Byte transmission time, the start of a new communication frame is indicated.

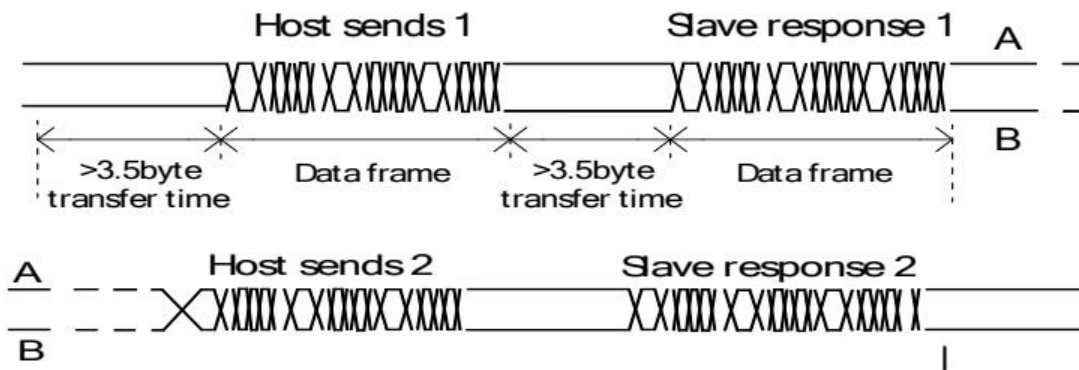

The built-in communication protocol of the vector universal inverter is the Modbus-RTU slave communication protocol, which

can respond to the "query / command" of the host, or make the corresponding actions according to the "query / command" of the host, and communicate the data response. The host can refer to a personal computer (PC), industrial control device or programmable logic controller (PLC), etc. The host can communicate separately with a slave, and release broadcast information to all lower attendants. For the separate access Query / command of the host, the accessed slave returns a response frame; for the host broadcast information, the slave does not need to respond back to the host.

7.22 Communication data structure

The Modbus-RTU protocol communication data format of the vector universal inverter is as follows. The converter only supports reading or write of Word parameters, the corresponding communication read command is 0x03; write command is 0x06, does not support byte or bit read and write operation:

The main station reads the command frame

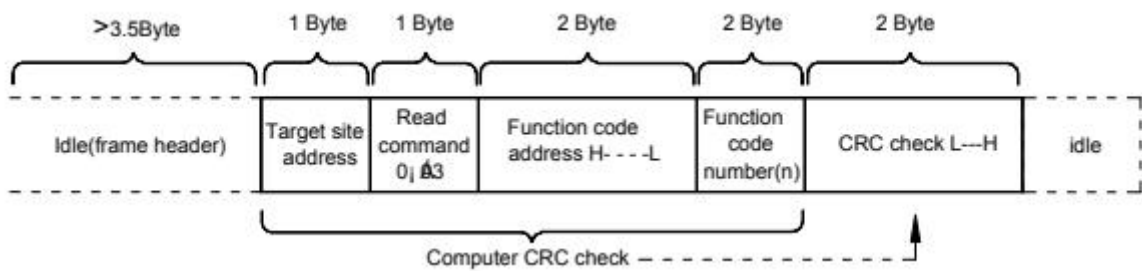

In theory, the upper computer can read several consecutive function codes at a time (that is, the maximum of n is up to 12), but note that it can not cross the last function code of this function code group, otherwise the reply will be wrong.

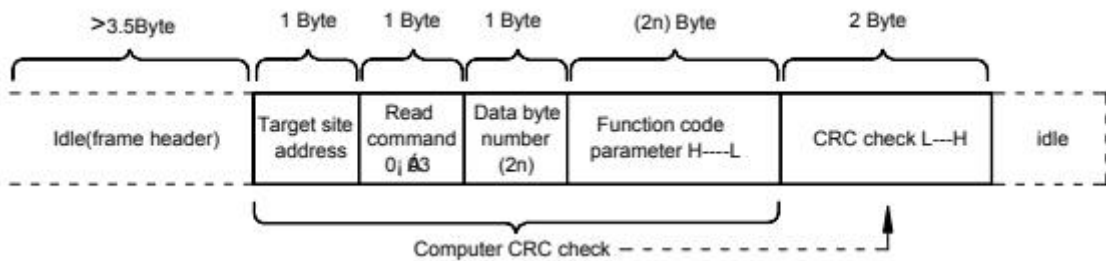

Read the response frame from the station

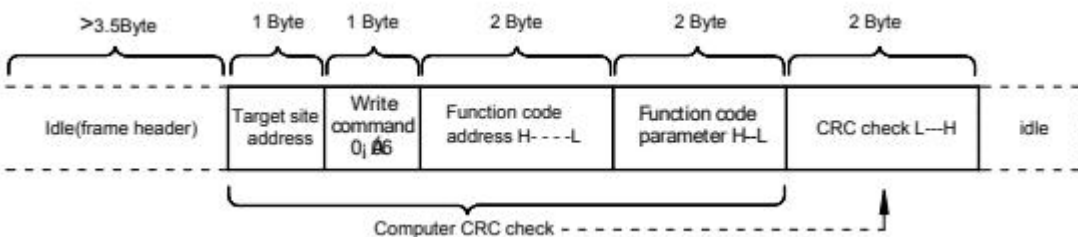

Write the answer frame from the station

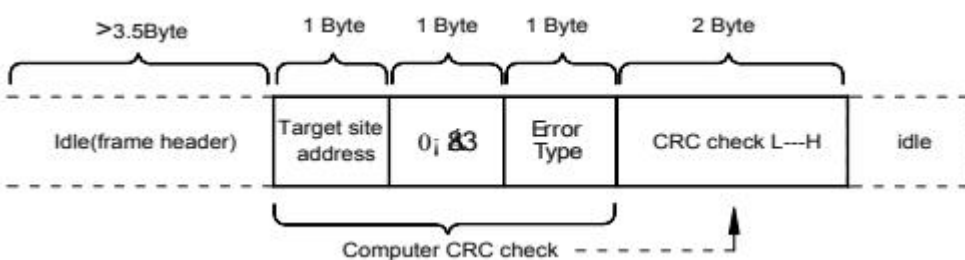

If a communication frame error is detected from the machine or is unsuccessful reading and writing due to other reasons, the wrong frame will be answered.

Station-read answer error frame

type of error
01: Command code error 02: Address error 03: Data error 04: The command cannot be processed

From the station to write the answer error frame

The Data Frame field description:

Frame-head, START	Idle with more than a 3.5-character transfer time
SROM Address ADR	Communication address range: 1 ~247; 0 = Broadcast address
command code CMD	03: Read the slave parameters; 06: Write the slave parameters
Function code address H	The parameter address inside the inverter is expressed in 16 decimal system; divided into functional code type and non-functional code type (such as running status parameters, operation
Function code address L	
Number of function codes: H	For the number of functional codes read in this frame, 1 functional code is read. When transmitting, high bytes before and low bytes after. This protocol can only be rewritten by 1, a
Number of function codes, L	
data H	Answer data, or data to be written, is transmitted with high bytes earlier and low bytes later.
data L	
CRC CHK Low Level	Detection value: CRC16 check value. When transmitting, low bytes before and high bytes after. The CRC CHK high-level calculation method is detailed in the CRC calibration description in this
CRC CHK High Level	
END	When at 3.5 characters

The CRC calibration mode:

The CRC (Cyclical Redundancy Check) uses the RTU frame format, and the message includes an error detection domain based on the CRC method. The CRC domain detects the content of the entire message. The CRC domain is two bytes that contain a 16-bit binary value. It is calculated by the transmission device and added to the message. The receiving device recalculates the CRC of the received message and compares it with the value in the received CRC domain. If the two CRC values are unequal, there is a transmission error. The CRC is done by first saving the 0xFFFF and then calling a procedure to process the consecutive 8-bit bytes in the message with the value in the current register. Only the 8Bit data in each character is valid for the CRC, and both the start and stop bits and the parity bits are invalid. During CRC generation, each 8-bit character is separate or (XOR) from the register content, and the result is moving towards the lowest effective bit, with the highest effective bit filled with zero. The LSB was extracted for detection, and was not performed if the LSB was 1, the register alone and the preset values were different or, and if the LSB was 0. The entire process was repeated 8 times. After the last digit (the 8th digit) is completed, the next 8-bit byte is separate from the current value of the register. The value in the final register is the CRC value after all the bytes in the message are executed. When a CRC is added to a message, low bytes join first, then high bytes. The CRC simple functions are as follows:

```
unsigned int crc_chk_value ( unsigned char *data_value,unsigned char length ) {
```



```

unsigned int crc_value=0xFFFF;
int i;
while (length-- ) {
    crc_value^=*data_value++;
    for (i=0;i<8;i++) {
        if ( crc_value&0x0001)
        {
            crc_value= (crc_value>>1)
^0xa001;
        }
        Else
        {
            crc_value=crc_value>>1;
        }
    }
}
return (crc_value) ;
}
    
```

Address definition of the communication parameter

Read and write function code parameters (some function codes cannot be changed, only for the manufacturer or monitoring):

7.23 Function code parameter and address labeling rules

Represents rules with function code group numbers and labels as parameter addresses:

High Level Bytes: F0~FF (Group F), A0~AF (Group A), 70~7F (Group U)

Low Bytes: 00~FF

For example, to access the function code F3.12, the access address of the function code is represented 0xF30C;

Note: FF group: you can neither read nor change parameters; U group: can only read, can not change parameters.

Some parameters should not be changed when the converter is in operation; some parameters cannot be changed whatever state the converter is;

Change the function code parameters, but also pay attention to the parameter range, units, and related instructions.

Function code group number	Communication access address	Communication modifies the function code address in the RAM
F0~FE group	0xF000~0xFEFF	0x0000~0x0EFF
A0~AC group	0xA000~0xACFF	0x4000~0x4CFF
U0 group	0x7000~0x70FF	Communication modifies the function code address in the RAM

Note that because EEPROM is being stored frequently, it reduces the service life of EEPROM, so some function codes are not stored in communication mode, but you just need to change the value in the RAM. If it is a group F parameter, to implement this function, just by changing the high F of the function code address to 0. If the group A parameter, to implement this function, just by changing the high A of the function code address to 4.

The corresponding function code address is indicated as follows:

High Bytes: 00~0F (group F), 40~4F (Group A)

Low Bytes: 00~FF

in compliance with:

The function code F3.12 is not stored in the EEPROM, and the address representation is 030C;

The function code A0.05 is not stored in EEPROM and the address is 4005;

This address means that can only write RAM, can not do read action, read, is invalid address.

This function can also be implemented using the command code 07H for all parameters.

Stop / Operation Parameters section:

Parameter address	parametric description
1000H	* Communication settings (decimal) 10000 ~ 10000
1001H	running frequency
1002H	busbar voltage
1003H	output voltage
1004H	output
1005H	output power
1006H	output torque
1007H	running speed
1008H	The X-terminal input flag
1009H	DO output flag
100AH	VCI voltage
100BH	CCI voltage
100CH	Panel potentiometer voltage
100DH	Count the numerical input
100EH	Length value input
100FH	loading speed
1010H	PID set up
1011H	PID feedback
1012H	PLC step
1013H	X5 terminal input pulse frequency per 0.01kHz 1014H feedback speed in 0.1Hz
1014H	Feedback speed, in a unit of 0.1Hz
1015H	The remaining running time
1016H	VCI correction front voltage
1017H	The CCI correction front voltage
1018H	Panel potentiometer correction front voltage

1019H	linear velocity
101AH	Current power time
101BH	Current run time
101CH	The X5 terminal input pulse frequency, in unit
1Hz101DH	Communication set value
101EH	Actual feedback speed
101FH	The primary frequency is shown
1020H	The auxiliary frequency is shown

pay attention to:

The communication set-point is the percentage of the relative values, with 10,000 corresponding to 100.00%, and -10,000 corresponding to -100.00%.

For the frequency dimension data, the percentage is the percentage of the relative maximum frequency (F0.10); for the torque dimension data, the percentage is F2.10, A2.48 (the torque upper limit number is set, corresponding to the first and second motors respectively).

Control command input to frequency converter: (write only)

Control command address	Command function
2000H	1: Forward operation, 2: reverse operation, 3: forward point operation
	4: Reverse point move 5: free shutdown 6: deceleration shutdown 7: fault complex

Read the frequency converter status: (read-only)

status word address	State word function
3000H	0001: Forward operation 0002: reverse operation 0003: shutdown

Parameter lock password check: (if return, 8888H, means the password verification)

Password address	Enter the contents of the password
1F00H	*****

Digital output terminal control: (write-only)

command address	Command content
2001H	BIT0: DO1 Output control BIT1: DO2 output control BIT2: RELAY1 output control
	BIT3: RELAY2 output control BIT4: DO output control BIT5: VDO1 BIT6: VDO2
	BIT7: VDO3 BIT8: VDO4 BIT9: VDO5

Analog output AO1 control: (write-only)

command address	Command content
-----------------	-----------------

2002H	0~7FFF representation 0%~100%
-------	-------------------------------

Analog output AO2 control: (write-only)

command address	Command content
2003H	0~7FFF representation 0%~100%

Pulse (X5) Output control: (write-only)

command address	Command content
2003H	0~7FFF representation 0%~100%

frequency converter fault description:

The frequency converter fault address	Frequency converter fault information
8000H	0000: No fault 0001: retention 0002: acceleration overcurrent 0003: deceleration overcurrent
	0004: constant speed overcurrent, 0005: accelerated overvoltage, 0006: deceleration overvoltage
	0007: constant speed overvoltage 0008: buffer resistance overload fault 0009: undervoltage fault
	000A: inverter overload 000B: motor overload 000C: input phase
	000D: Output phase absence, 000E: module overheating, 000F: external fault
	0010: Communication anomaly 0011: contactor anomaly 0012: current detection fault
	0013: Motor tuning fault 0014: encoder / PG card fault 0015: parameter reading and writing
	0016: Frequter hardware failure 0017: Motor short circuit to ground fault 0018: reserved
	0019: Hold 001A: Runtime reaches 001B: User custom fault 1
	001C: User custom fault 2 001D: power time reaches 001E: drop
	001F: Runtime PID feedback loss 0028: Fast flow limit timeout fault
	0029: Switching motor fault 002A: excessive speed deviation 002B: motor overspeed
	002D: Motor over-temperature 005A: Encoder line number setting error 005B: Unconnected encoder
	005C: Initial position error, 005E: Speed feedback error

7.24 Description of the F D group communication parameters

Fd-00	Porter range	Factory value	6005
	Set the scope	Individual bit: MODBUS Porter rate	
		0: 300BPS 1: 600BPS 2: 1200BPS 3: 2400BPS 4: 4800BPS 5: 9600BPS 6: 19200BPS 7: 38400BPS 8: 57600BPS 9: 115200BPS	

This parameter is used to set the data transmission rate between the upper position computer and the frequency converter. Note that the wave rate set by the upper computer and the inverter must be consistent, otherwise, the communication cannot be conducted. The greater the port rate, the faster the communication speed.

Fd-01	data format	Factory value	0
	Set the scope	0: No check: data format <8, N, 2>	
		1: Partial test: data format <8, E, 1>	
		2: Strange check: data format <8, O, 1>	
		3: No calibration: Data format <8-N-1>	

The data format set by the upper computer and the inverter must be consistent, otherwise, the communication cannot be carried out.

Fd-02	This machine address	Factory value	1
	Set the scope	1~247,0 is a broadcast address	

When the local address is set to 0, it is the broadcast address, realizing the host computer broadcast function.

Native address is unique (except broadcast address), which is the basis of point-to-point communication between upper computer and frequency converter.

Fd-03	Response delay	Factory value	2ms
	Set the scope	0~20ms	

Response delay: refers to the intermediate interval between the inverter data acceptance end and the data sent by the upward computer. If the response delay is less than the system processing time, the response delay shall be subject to the system processing time. If the response delay is longer than the system processing time after processing, the system will delay to send the data until the response delay time reaches.

Fd-04	Communication timeout time	Factory value	0.0 s
	Set the scope	0.0s (invalid); 0.1~60.0s	

The communication timeout parameter is invalid when the function code is set to 0.0s. When the function code is set to a valid value, if the interval between one communication and the next communication exceeds the communication overtime time, the

Fd-05	Communication protocol selection	Factory value	0
	Set the scope	0: Non-standard Modbus-RTU protocol; 1: Standard Modbus-RTU protocol	

system will report a communication fault error (Err16). Usually, it is set to be invalid. If in a continuous communication system, you set the subparameter, you can monitor the communication status.

Fd-05=1: Select the standard Modbus protocol.

Fd-05=0: When reading the command, there are one more returned bytes than the standard Modbus protocol, please refer to the "5 Communication Data Structure" section of this protocol.

Fd-06	Communication to read the current resolution	Factory value	0
	Set the scope	0: 0.01A; 1: 0.1A	

Used to determine the output unit of the current value when the communication reads the output current.

Appendix A for Installation and Dimensions (mm)

series	product model	Rated input voltage	outline dimension (mm)	installation size (mm)
Inverter	0R4ST2	220V	89.7*179*145	71.4*184.2
	0R7ST2	220V		
	1R5ST2	220V		
	2R2ST2	220V		
	0R7G/1R5PT4	380V		
	1R5G/2R2PT4	380V		
	2R2G/4R0PT4	380V		
	4R0G/5R5PT4	380V		
	5R5G/7R5PT4	380V	102*200*165	90*189.8
	7R5G/011PT4	380V		
	011G/015PT4	380V	125*240*175	108*227.5
	015G/018PT4	380V		
	018G/022PT4	380V	215*345*215	140*320
	022G/030PT4			
	030G/037PT4	380V		
	037G/045PT4	380V	295*525*225	160*505
	045G/055PT4	380V		
	055G/075PT4	380V	340*530*250	200*510
	075G/090PT4	380V	340*580*250	200*560
	090G/110PT4	380V	400*610*290	240*590
	110G/132PT4	380V		
	132G/160PT4	380V		
	160G/185PT4	380V	500*780*350	400*760
	185G/200PT4	380V		
	200G/220PT4	380V		
	220G/245PT4	380V		
245G/280PT4	380V	750*860*460	500*840	
280G/315PT4	380V			
315G/355PT4	380V			
355G/400PT4	380V			

series	product model	Rated input voltage	outline dimension (mm)	installation size (mm)	
Inverter	245G/280PT4C	380V	1300*750*465	Cabinet machine	
	280G/315PT4C	380V			
	315G/355PT4C				
		355G/400PT4C	380V		1500*950*515
		400G/450PT4C	380V		
		450G/500PT4C	380V		
		500G/560PT4C	380V		1600*1050*515
		560G/630PT4C	380V		
		630G/710PT4C	380V		

Keyboard opening size (mm)

Model no.	W	H
0R4G-630G (Iron Case)	82	126